

CHIP MONOLITHIC CERAMIC CAPACITORS AS ALTERNATIVES FOR CHIP TANTALUM CAPACITORS

C-24-C

muRata
Innovator in Electronics

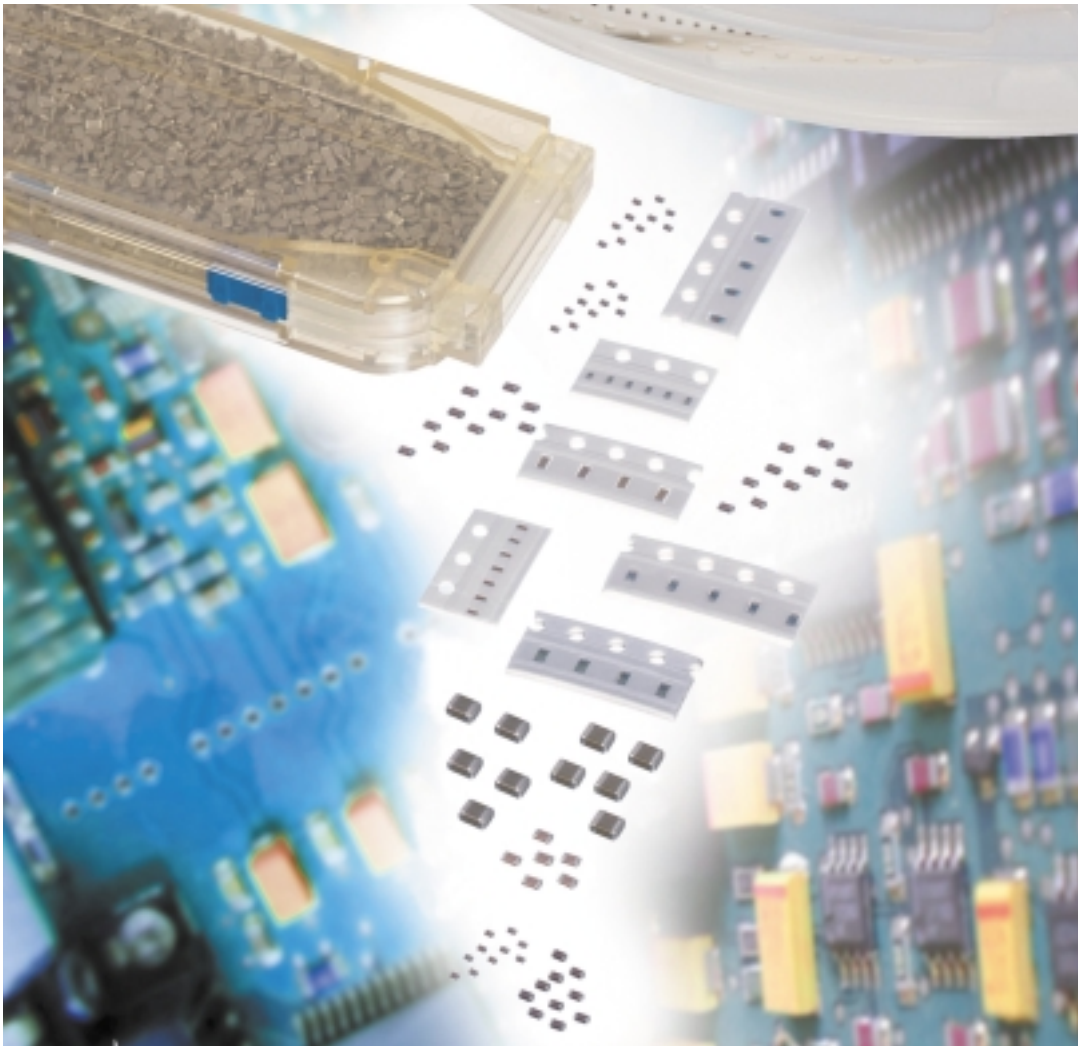

Please visit our website
www.murata.com

Murata Electronics
North America, Inc.

Page	Topic
2.	Comparative Capacitance Table (see below)
3.	Basic Function and Applications
4.	Recommended P/N's
5.	Case Size and Part Numbering Description
6.	(Cap-vs-Freq.) and (Impedance/ESR-vs-Freq.) - 10uF
7.	(Cap-vs-Freq.) and (Impedance/ESR-vs-Freq.) - 47uF
8.	Noise Absorption Comparison - 10uF (10kHz - 1MHz)
9.	Noise Absorption Comparison - 10uF (Low-pass filter characteristic)
10.	Noise Absorption/Smoothing Comparison - 47uF
11.	Noise Absorption Comparison - 100uF (Low-pass filter characteristic)
12.	Breakdown Voltage Characteristics
13.	Capacitance-vs-Temperature
14.	DC/AC Voltage Characteristics
15.	Self-Heating-vs-Ripple Current

Comparative Capacitance Table

Capacitor	EIA	Size (mm)			Capacitance					
		L	W	T	1nF	10nF	100nF	1uF	10uF	100uF
Murata MLCC	0201	0.6	0.3	0.3	█					
	0402	1.0	0.5	0.5	█	█				
	0603	1.6	0.8	0.8	█	█	█			
	0805	2.0	1.25	1.25	█	█	█	█		
	1206	3.2	1.6	1.6	█	█	█	█		
	1210	3.2	2.5	2.5		█	█	█	█	
	1812	4.5	3.2	2.5			█	█	█	
	2220	5.7	5.0	3.2				█	█	█
TA (X)	P	2.0	1.25	1.1				█		
	A2	3.2	1.6	1.1				█		
	A	3.2	1.6	1.6				█		
	B2	3.5	2.8	1.9					█	
	C	6.0	3.2	2.5					█	
	V	7.3	4.3	1.9					█	
	D	7.3	4.3	2.8					█	█
TA (Y)	CD(thin type)	7.3	4.3	1.5				█		
	CD Series	7.3	4.3	1.8				█	█	
	UD Series	7.3	4.3	3.1					█	
	UE Series	7.3	4.3	4.2						█
Organic Semi- Conductive	A	7.3	4.6	4.6				█		
	B	7.3	5.6	5.6					█	
	C	9.0	7.0	7.0					█	
	D	12.0	7.0	7.0					█	
	E	13.0	8.8	8.8						█

Basic Function and Applications for High Capacitance Components



Basic Function

Electrical signals contain various noise components such as EMI or equipment-generated noise.

High Capacitance can be used to reduce these noise signals and provide a more stable operating system.

The most prominent functions for high capacitance are shown below:

Smoothing

DC signals are cleaned by using high capacitance to absorb ripple voltage.



Bypassing

When high capacitance is used in a filtering circuit, unwanted signals can be routed away from certain equipment, e.g., bypassing high frequency noise.



Coupling

Coupling between neighbor circuits to stop DC and pass AC

Advantages of MLCC in comparison to TA/AL capacitors.

- Noise Absorption of MLCC is excellent compared to Ta/AL Capacitors.
- Self Heating of MLCC is small compared to TA/AL Capacitors.
- Capacitance of MLCC does not change over a wide frequency range.
- Break down Voltage of MLCC is higher compared to TA/AL Capacitors.

Recommended Murata MLCC P/N's For Replacement of TA/AL Chips

Smoothing / By-passing: $\leq 100\text{kHz}$

TA /AL	MLCC	6.3V	10V	16V	25V	35V / 50V
0.1uF → 0.047uF		-->	GRM36X7R473K010A_	-->	GRM39X7R473K025A_	GRM40X7R473K050A_
		-->	GRP155R71A473KA01_	-->	GRM188R71E473KA01_	GRM21BR71H473KA01_
0.22uF → 0.1uF		-->	GRM36X5R104K010A_	-->	GRM39X7R104K025A_	GRM40X7R104K050A_
		-->	GRP155R61A104KA01_	-->	GRM188R71E104KA01_	GRM21BR71H104KA01_
0.47uF → 0.22uF		-->	GRM39X7R224K010A_	-->	GRM40X7R224K025A_	GRM40X7R224K050A_
		-->	GRM188R71A224KA01_	-->	GRM219R71E224KC01_	GRM21BR71H224KA01_
1.0uF → 0.47uF		GRM39X5R474K63A_	GRM40X7R474K016A_	GRM40X7R474K016A_	GRM40X7R474K025A_	GRM42-6X7R474K050A_
		GRM188R60J474KA01_	GRM219R71C474KA01_	GRM219R71C474KC01_	GRM21BR71E474KC01_	GRM31MR71H474KA01_
2.2uF → 1.0uF		GRM39X5R105K63A_	-->	GRM40X7R105K016A_	GRM42-6X7R105K025A_	GRM42-2X7R105K050A_
		GRM188R60J105KA01_	-->	GRM21BR71C105KA01_	GRM31MR71E105KC01_	GRM32RR71H105KA01_
4.7uF → 2.2uF		GRM40X5R225K63A_	GRM42-6X5R225K010A_	GRM42-6X7R225K016A_	GRM42-2X7R225K025A_	
		GRM21BR60J225KC01_	GRM31MR61A225KA01_	GRM31MR71C225KC11_	GRM32RR71E225KC01_	
10uF → 4.7uF		GRM40-034X5R475K63A_	GRM42-6X5R475K010A_	GRM42-6X5R475K016A_	GRM42-2X5R475K025A_	GRM44-1X7R475K050A_
		GRM21BR60J475KA11_	GRM31CR61A475KA01_	GRM31CR61C475KA45_	GRM32RR61E475KC31_	GRM55ER71H475KA01_
22uF → 10uF		GRM42-6X5R106K63A_	GRM42-2X5R106K010A_	GRM42-2X5R106K016A_	GRM43-2X5R106K025A_	
		GRM31CR60J106KC01_	GRM32ER61A106KC01_	GRM32ER61C106KC31_	GRM43DR61E106KA01_	
47uF → 22uF		GRM42-2X5R226K63A_				
		GRM32DR60J226KA01_				
100uF → 47uF				Under Development		
220uF → 100uF		GRM44-1X5R107K63A_				
		GRM55XR60J107KA01_				

→ Due to the lower Z and ESR of MLCCs, capacitance values less than half that of the TA can be used in many by-passing or decoupling applications.

Coupling: $\leq 100\text{kHz}$

TA /AL	MLCC	6.3V	10V	16V	25V	50V
0.1uF	0.1uF	-->	GRM36X5R104K010A_	-->	GRM39X7R104K025A_	GRM40X7R104K050A_
		-->	GRP155R61A104KA01_	-->	GRM188R71E104KA01_	GRM21BR71H104KA01_
0.22uF	0.22uF	-->	GRM39X7R224K010A_	-->	GRM40X7R224K025A_	GRM40X7R224K050A_
		-->	GRM188R71A224KA01_	-->	GRM219R71E224KC01_	GRM21BR71H224KA01_
0.47uF	0.47uF	GRM39X5R474K63A_	-->	GRM40X7R474K016A_	GRM40X7R474K025A_	GRM42-6X7R474K050A_
		GRM188R60J474KA01_	-->	GRM219R71C474KC01_	GRM21BR71E474KC01_	GRM31MR71H474KA01_
1.0uF	1.0uF	GRM39X5R105K63A_	-->	GRM40X7R105K016A_	GRM42-6X7R105K025A_	GRM42-2X7R105K050A_
		GRM188R60J105KA01_	-->	GRM21BR71C105KA01_	GRM31MR71E105KC01_	GRM32RR71H105KA01_
2.2uF	2.2uF	GRM40X5R225K63A_	GRM42-6X5R225K010A_	GRM42-6X7R225K016A_	GRM42-2X7R225K025A_	
		GRM21BR60J225KC01_	GRM31MR61A225KA01_	GRM31MR71C225KC11_	GRM32RR71E225KC01_	
4.7uF	4.7uF	GRM40-034X5R475K63A_	GRM42-6X5R475K010A_	GRM42-6X5R475K016A_	GRM42-2X5R475K025A_	GRM44-1X7R475K050A_
		GRM21BR60J475KA11_	GRM31CR61A475KA01_	GRM31CR61C475KA45_	GRM32RR61E475KC31_	GRM55ER71H475KA01_
10uF	10uF	GRM42-6X5R106K63A_	GRM42-2X5R106K010A_	GRM42-2X5R106K016A_	GRM43-2X5R106K025A_	
		GRM31CR60J106KC01_	GRM32ER61A106KC01_	GRM32ER61C106KC31_	GRM43DR61E106KA01_	
22uF	22uF	GRM42-2X5R226K63A_				
		GRM32DR60J226KA01_				
47uF	47uF			Under Development		
100uF	100uF	GRM44-1X5R107K63A_				
		GRM55XR60J107KA01_				

Contact Murata Electronics for development plans of items not listed.

Legend	North America P/N	Contact Murata or an Authorized Representative for complete P/N including packaging "*" suffix.
	Global P/N Effective 6/01	

All part numbers shown are for commercial, non-critical applications only.



*Innovator
in Electronics*

Murata Electronics
North America, Inc.

Case Size and Part Numbering Description

(1) TA Chip Dimension

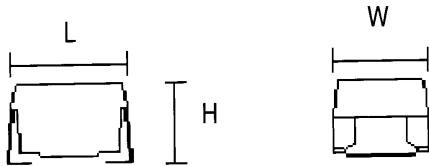

Case Code	Size		TA DIMENSION (mm)		
	(mm)	(in.)	L	W	H
P	2012	0805	2.0±0.2	1.25±0.2	1.2 max.
A (S*)	3216	1206	3.2±0.2	1.6±0.2	1.6±0.2
B (T*)	3528	1411	3.5±0.2	2.8±0.2	1.9±0.2
C (U*)	6032	2412	6.0±0.3	3.2±0.3	2.5±0.3
D (V*/X*)	7343	2917	7.3±0.3	4.3±0.3	2.8±0.3
E	7260	2917	7.3±0.3	6.0±0.3	3.6±0.3

(*Low or High profile case sizes)

(2) MLC Chip Dimension

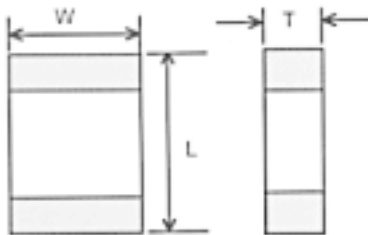

Murata Type	Size		MLCC DIMENSION (mm)		
	(mm)	(in.)	L	W	H
GRM36	1005	0402	1.0±0.05	0.5±0.05	0.5±0.05
GRM39	1608	0603	1.6±0.1	0.8±0.1	0.8±0.1
GRM40	2012	0805	2.0±0.15	1.25±0.15	1.4 max.
GRM42-6	3216	1206	3.2±0.2	1.6±0.2	1.8 max.
GRM42-2	3225	1210	3.2±0.3	2.5±0.2	2.7 max.
GRM43-2	4532	1812	4.5±0.4	3.2±0.3	2.7 max.
GRM44-1	5750	2220	5.7±0.43	5.0±0.4	3.4 max.

North America -vs- Global Part Numbering Comparison

Packaging										
Marking Digit (A = no marking)										
Rated Voltage										
Capacitance Tolerance										
Capacitance										
Temperature Characteristic										
Case Size										
Product Series ID										
North America PIN →	GRM	40	X7R	105	K	016	A	L		
Global PIN (Effective 6/01) →	GR	M	21	B	R7	1C	105	K	A01	L
Product ID										
Series/Terminal										
Dimension (L x W)										
Dimension (T)										
Temperature Characteristic										
Rated Voltage										
Capacitance										
Capacitance Tolerance										
Individual Specification										
Packaging										

The above example is for explanatory purposes only. Please consult Murata's catalog or Authorized Sales Representative to determine Murata part numbers.



Innovator
in Electronics

Murata Electronics
North America, Inc.

Capacitance -vs- Frequency

10uF

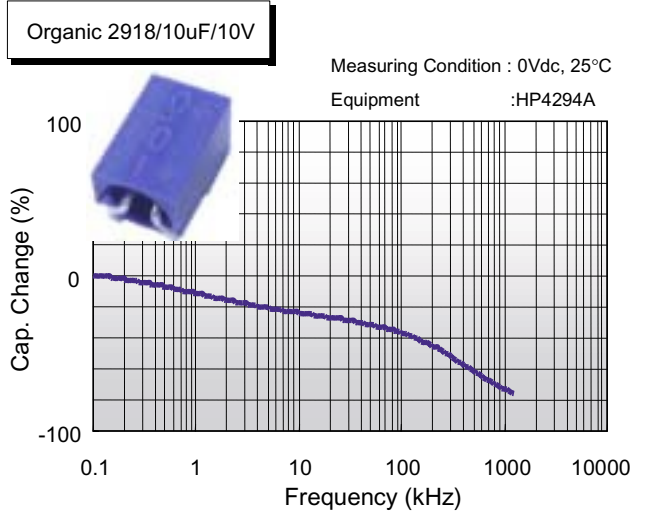
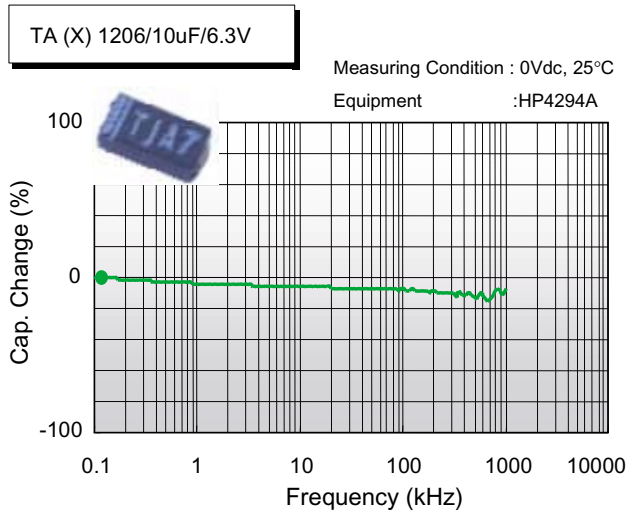
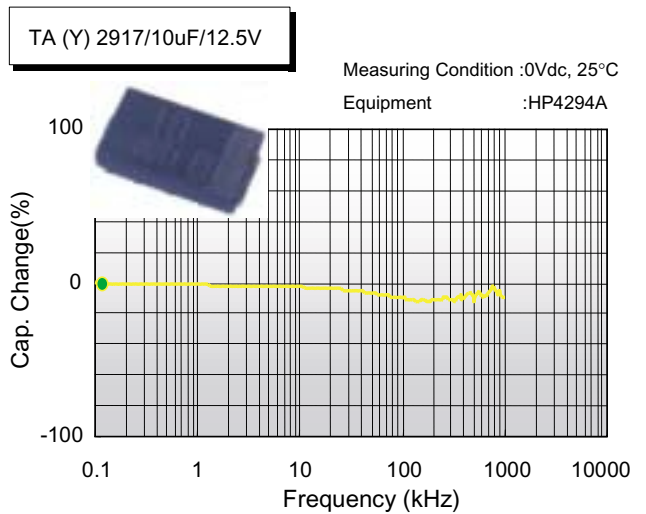
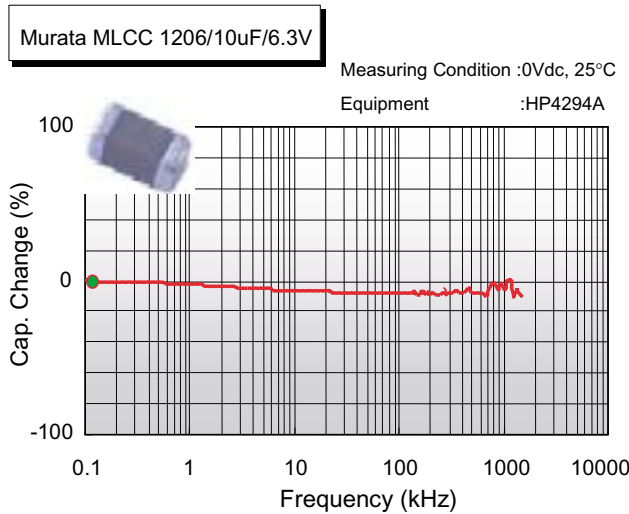

Impedance/ESR -vs- Frequency

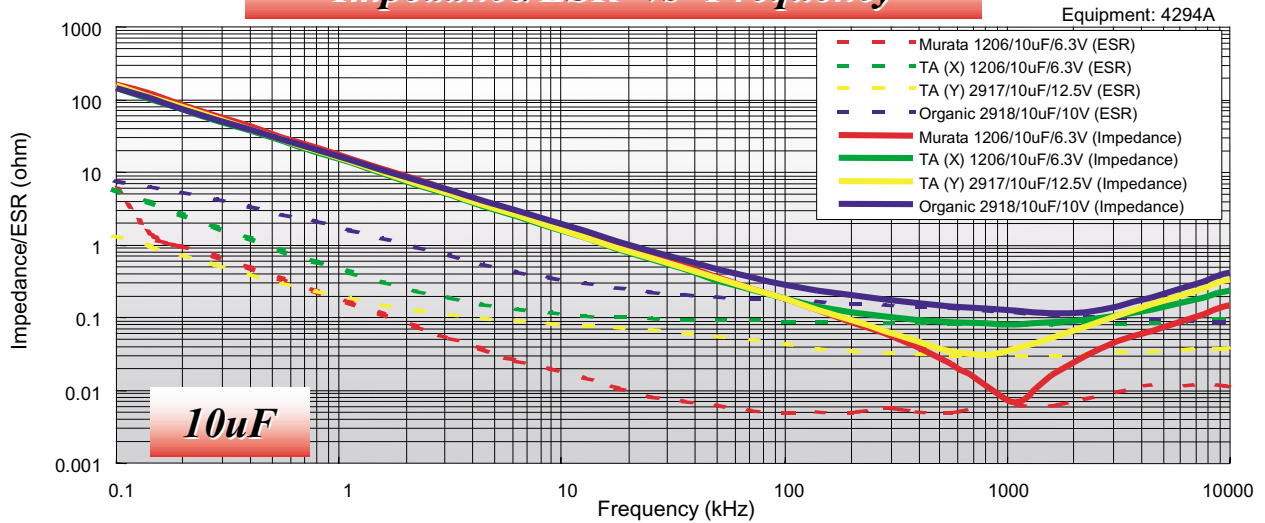

Capacitance -vs- Frequency

47uF

Murata MLCC 2220/47uF/16V

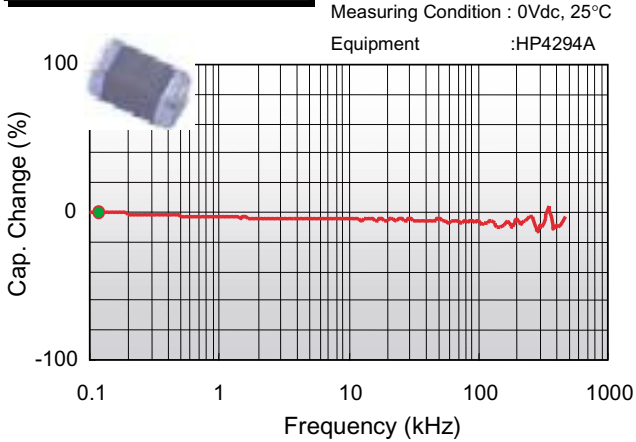

TA (Y) 2917/47uF/6.3V

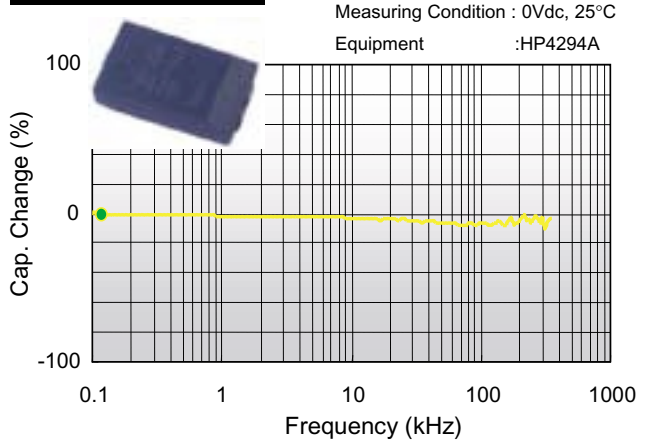

TA (X) 1411/47uF/6.3V

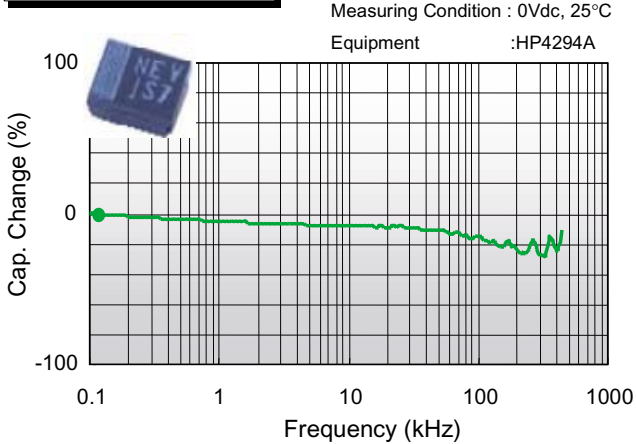

Organic 3628/47uF/10V

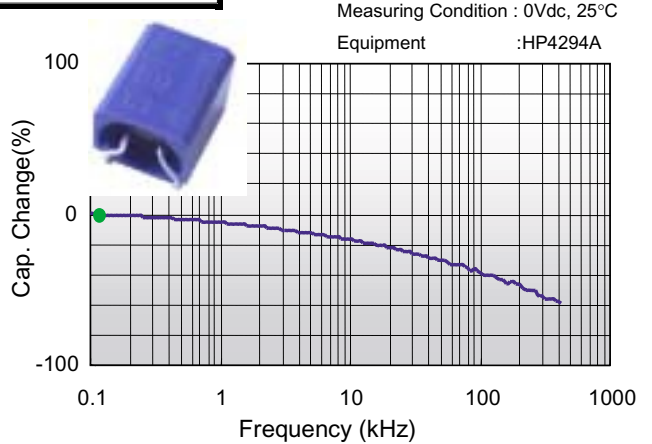

Impedance/ESR -vs- Frequency

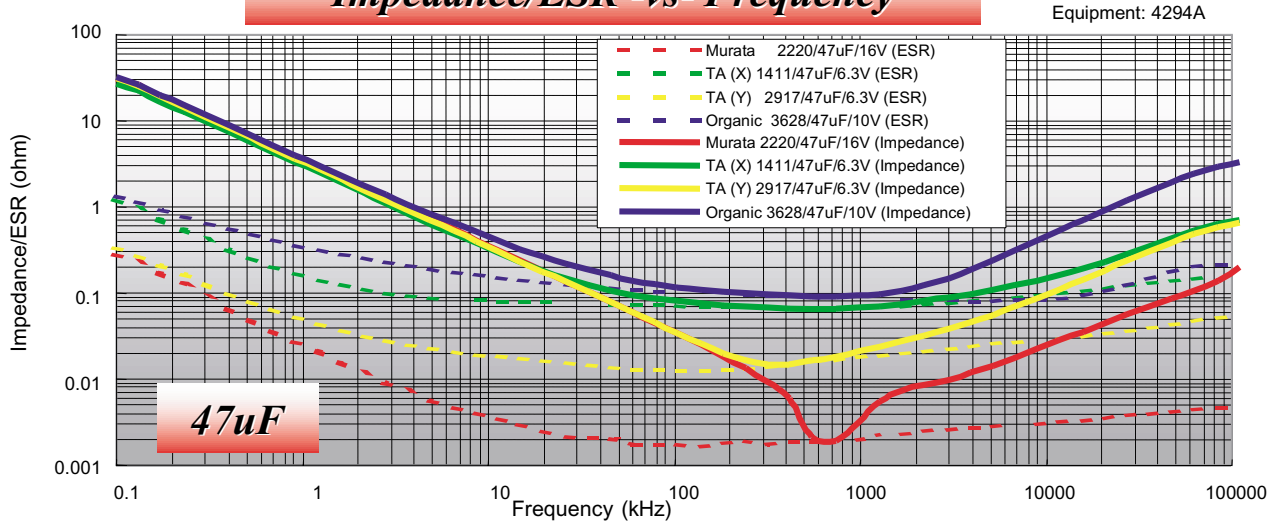

Noise Absorption Comparison 10uF (10kHz to 1MHz)

<Measurement Method>

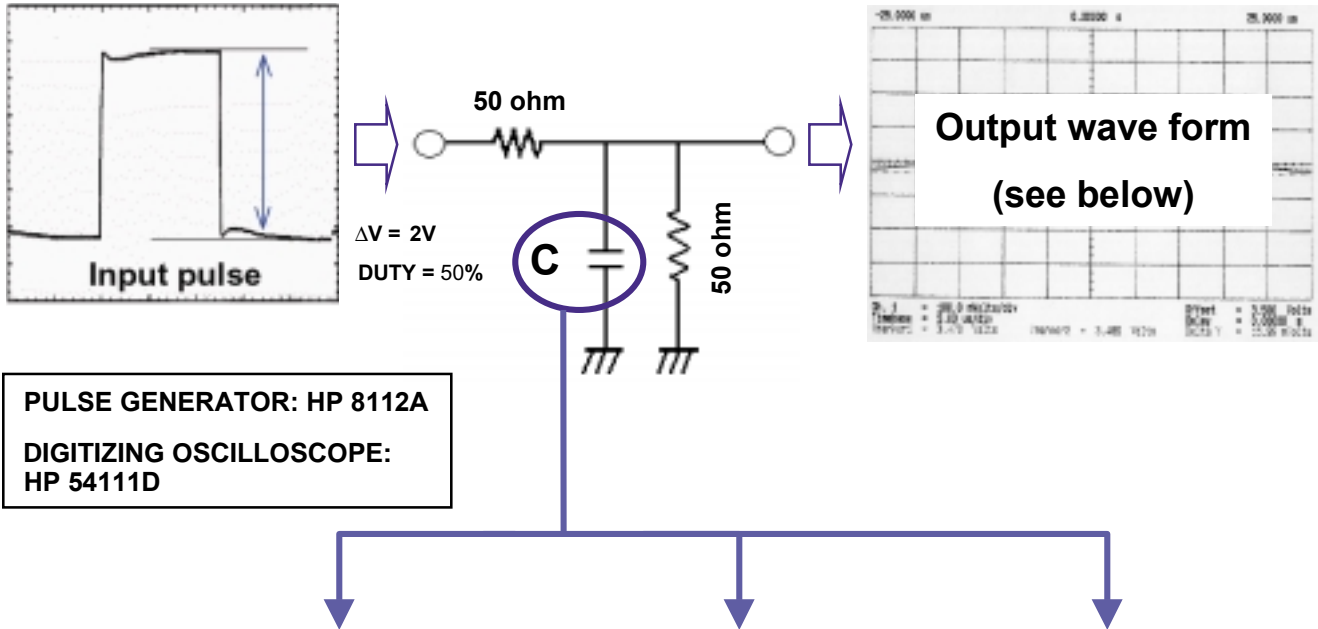

Capacitor frequency	10uF AL	10uF TA	10uF MLCC
10KHz Output wave	 534mv 50uS/div	 204mv 50uS/div	 196mv 50uS/div
100KHz Output wave	 366mv 5uS/div	 64mv 5uS/div	 16mv 5uS/div
1MHz Output wave	 332mv 500nS/div	 30mv 500nS/div	 3mv 500nS/div

Noise Absorption Comparison 10uF (Low-pass filter characteristic)

<Measurement Method>

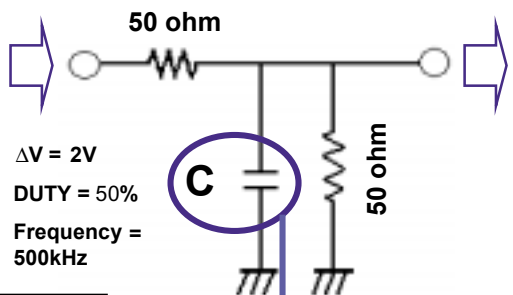
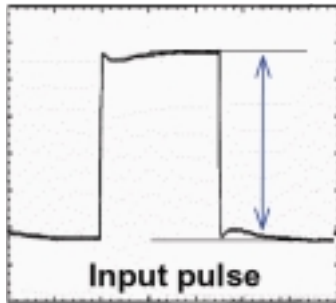

$\Delta V = 2V$
DUTY = 50%
Frequency = 500kHz

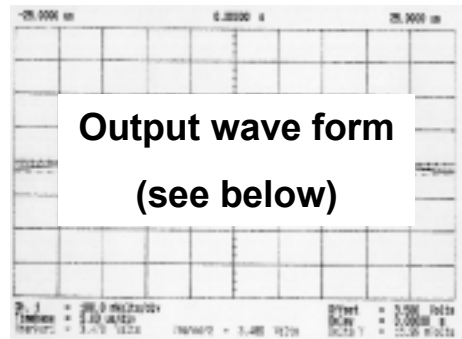

PULSE GENERATOR: HP 8112A
DIGITIZING OSCILLOSCOPE: HP 54111D

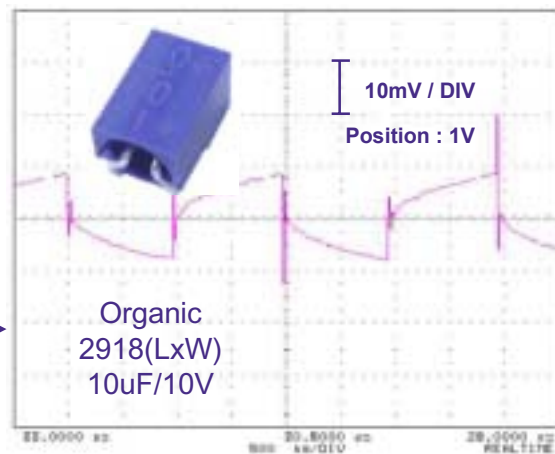
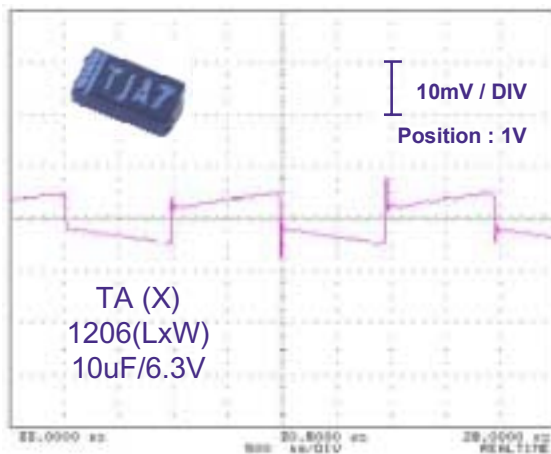
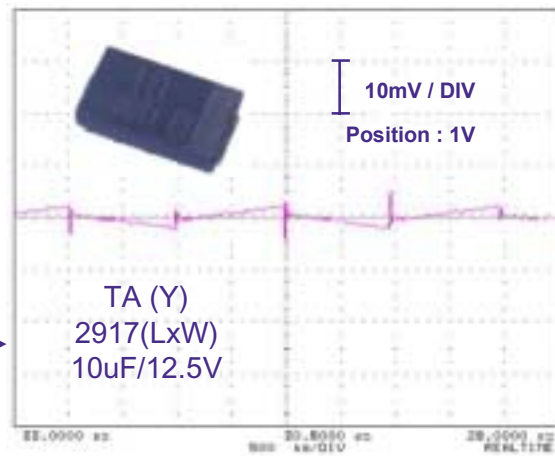
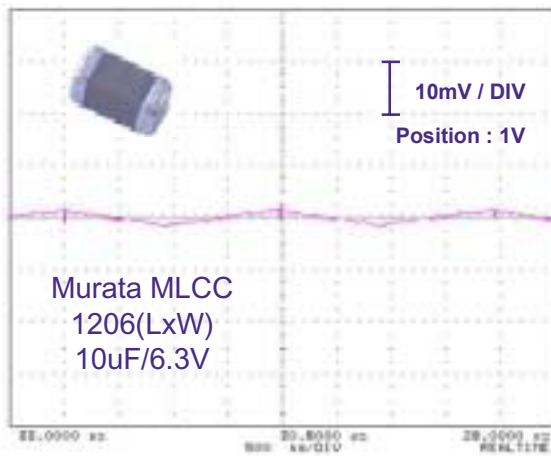

**Noise Absorption / Smoothing
Comparison
47uF**

Output wave form

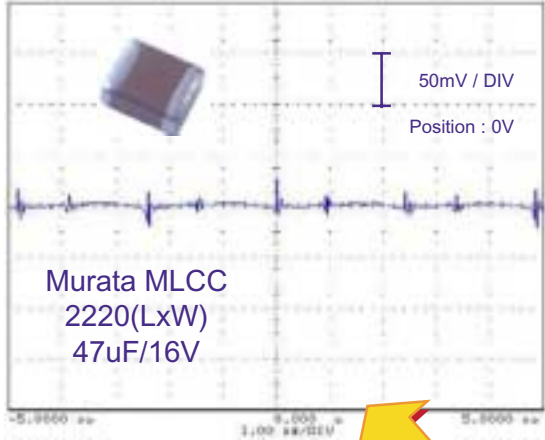

Output wave form

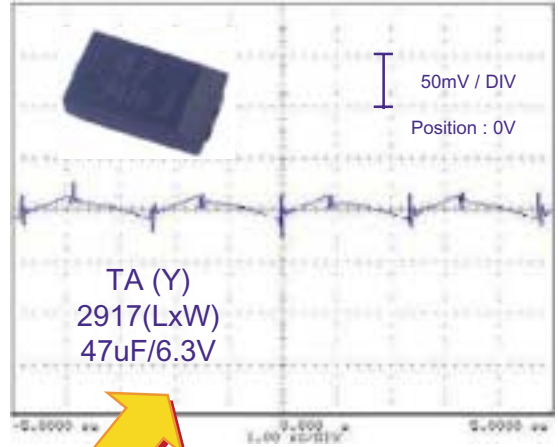

**Non-resonance type
forward method DC-DC
converter**

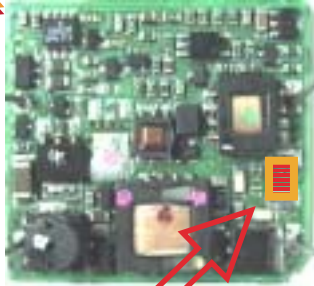

<Circuit Diagram>
<spec>
Input : 12 Vdc
Output : 5V x 4A (20W)
Switching freq.: 400kHz

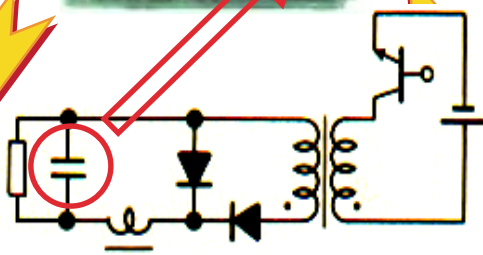

Output wave form

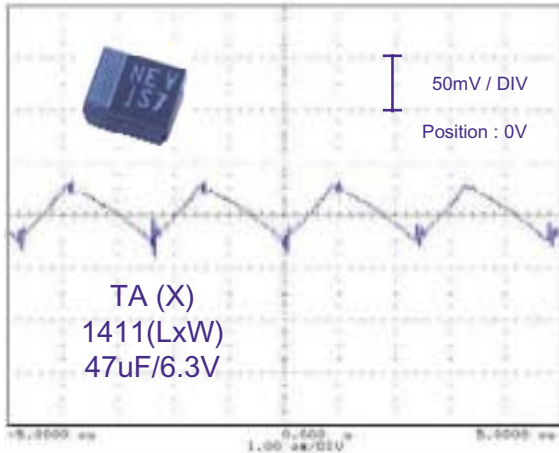

Output wave form

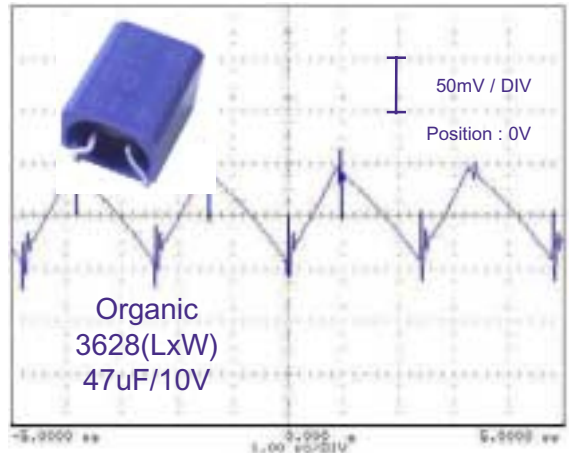

Noise Absorption Comparison 100uF (Low-pass filter characteristic)

<Measurement Method>

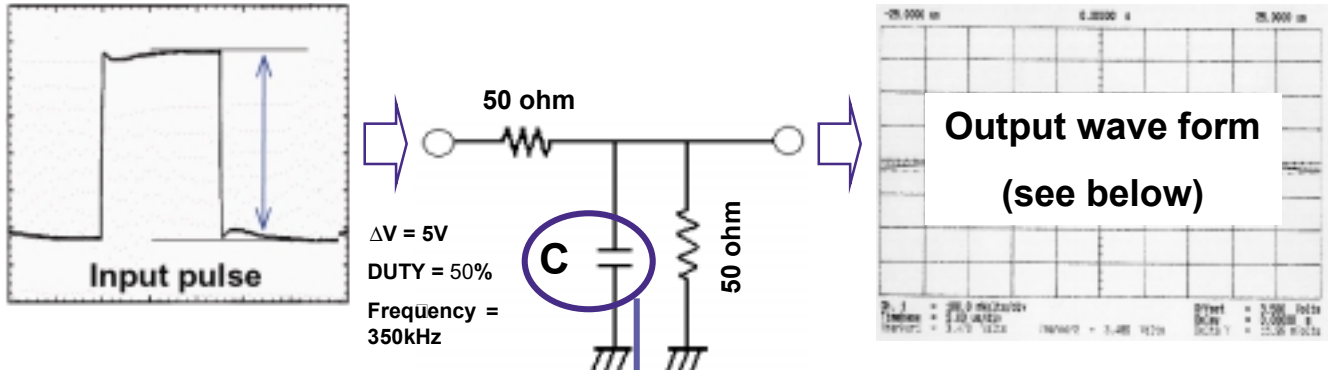

PULSE GENERATOR: HP 8112A
DIGITIZING OSCILLOSCOPE: HP 54111D

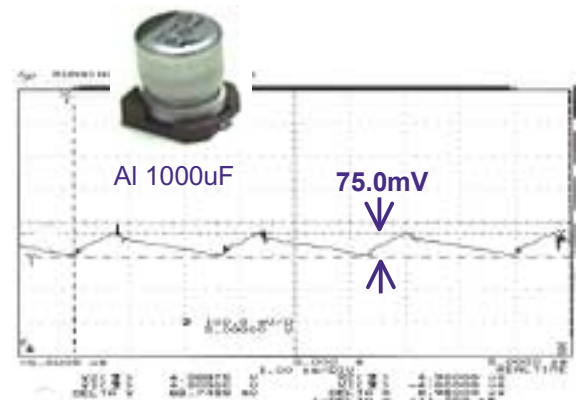
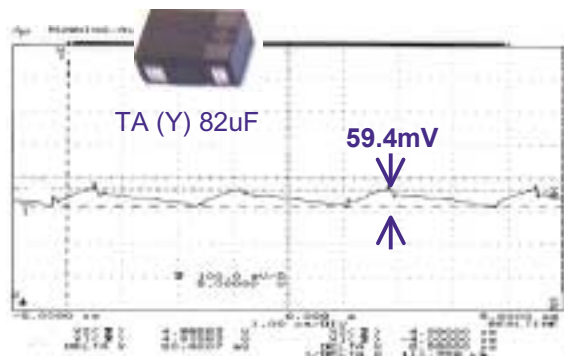
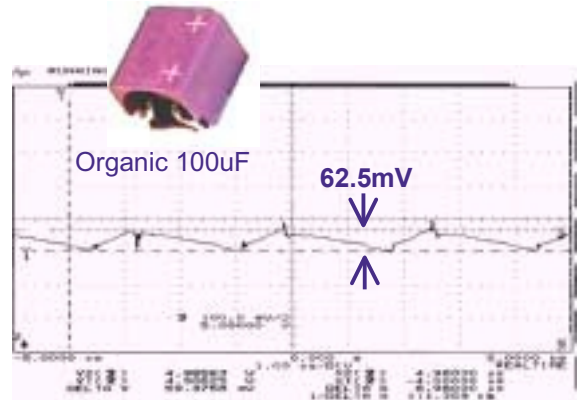
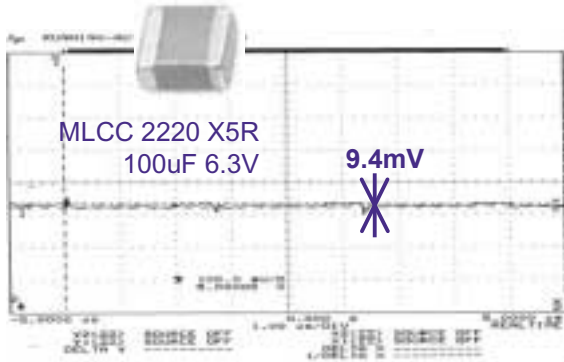



Innovator
in Electronics

Break Down Voltage

Murata Electronics
North America, Inc.

Equipment : GP0160-1

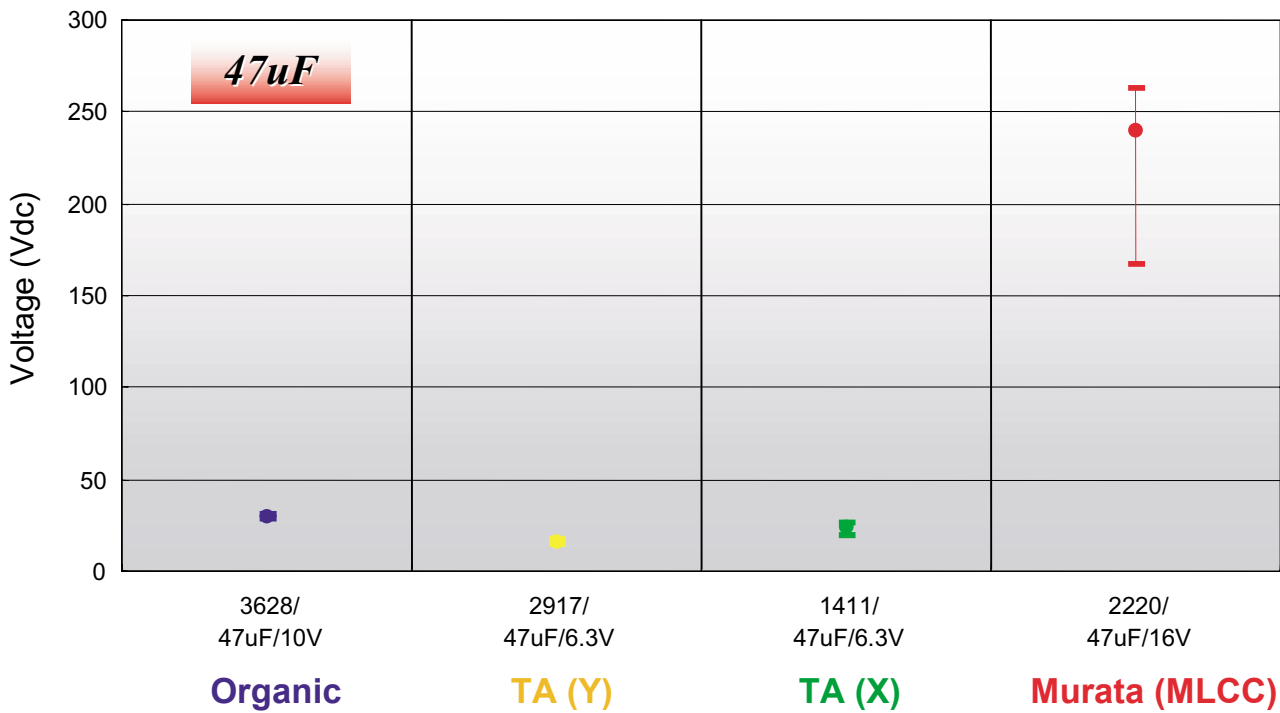
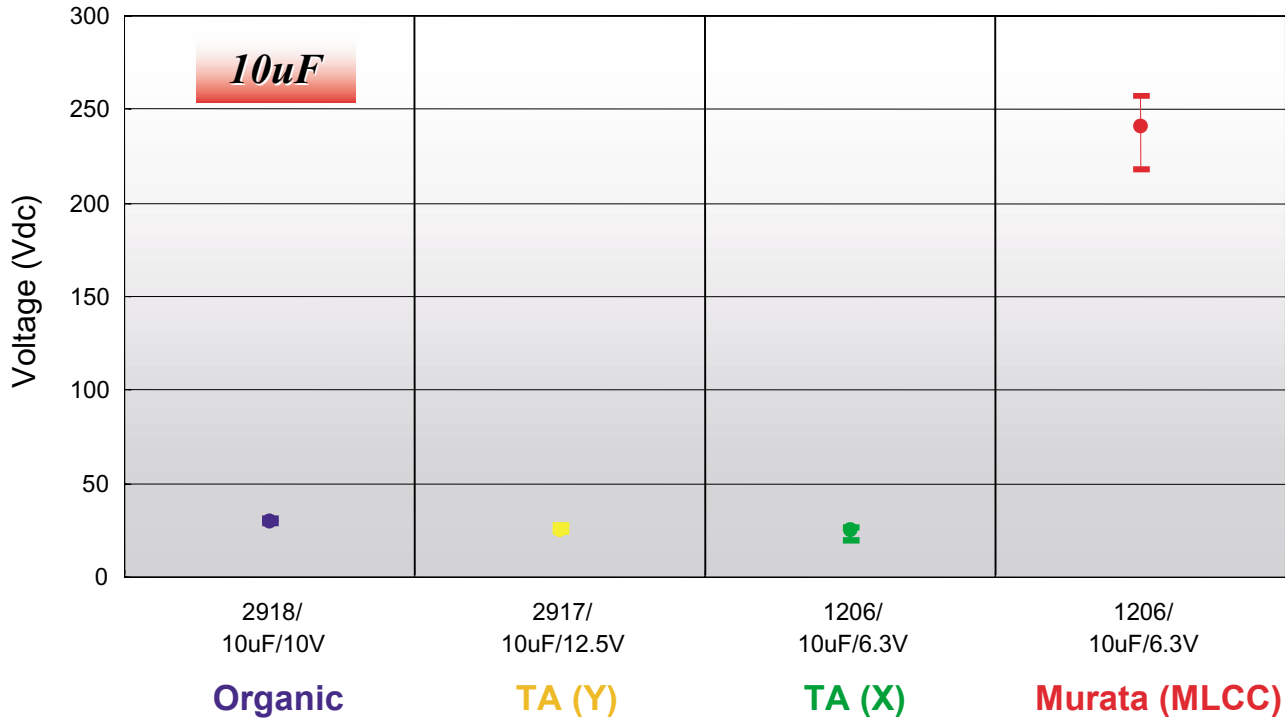



Innovator
in Electronics

Murata Electronics
North America, Inc.

Capacitance -vs- Temperature

Measuring Condition: 120Hz, 0.5Vrms
Equipment: 4284A

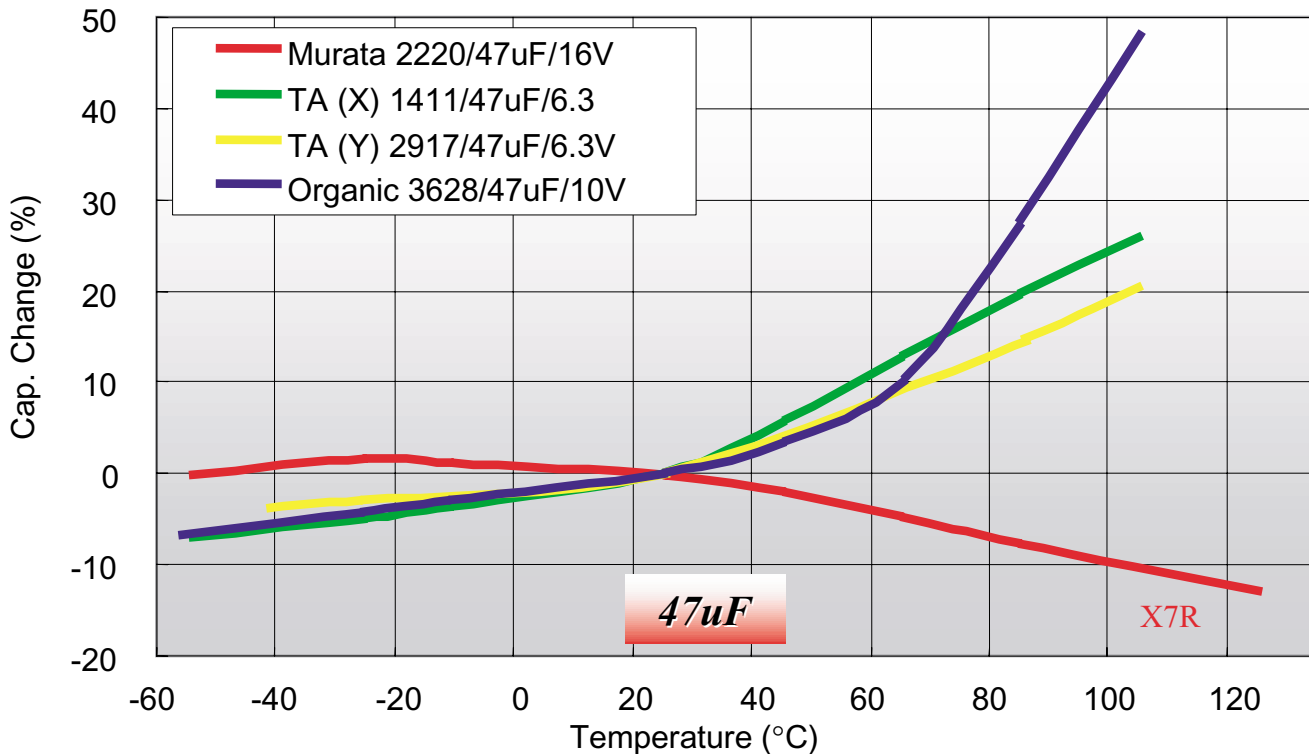
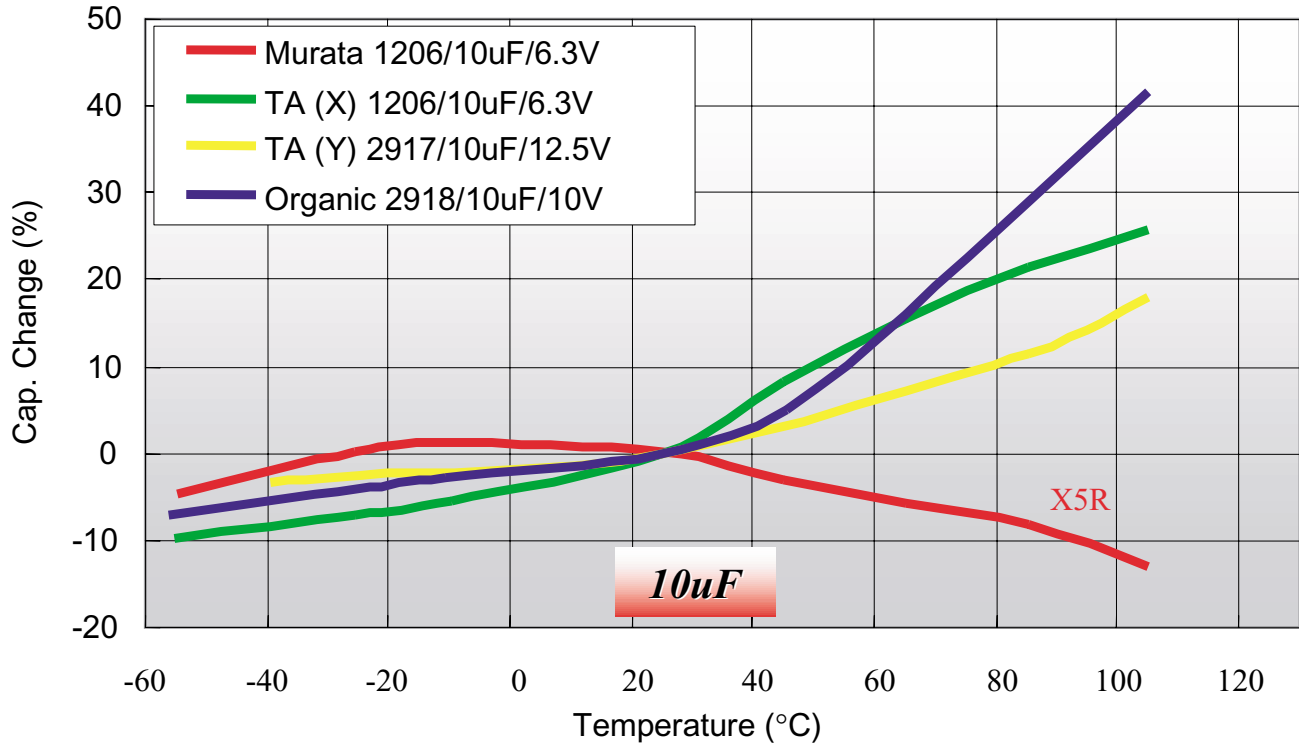



Innovator
in Electronics

Voltage Characteristics

Murata Electronics
North America, Inc.

DCV

10uF

ACVrms

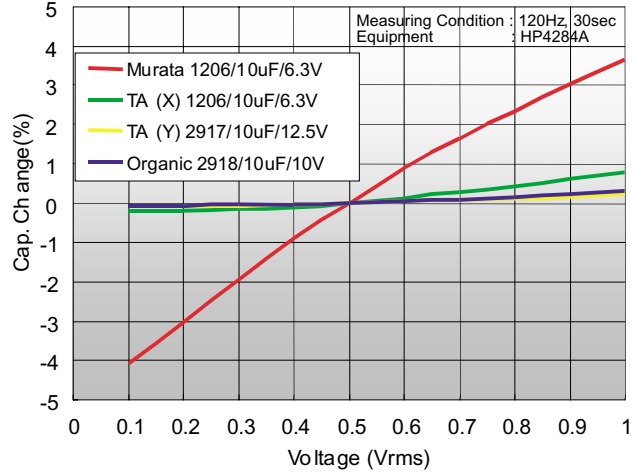
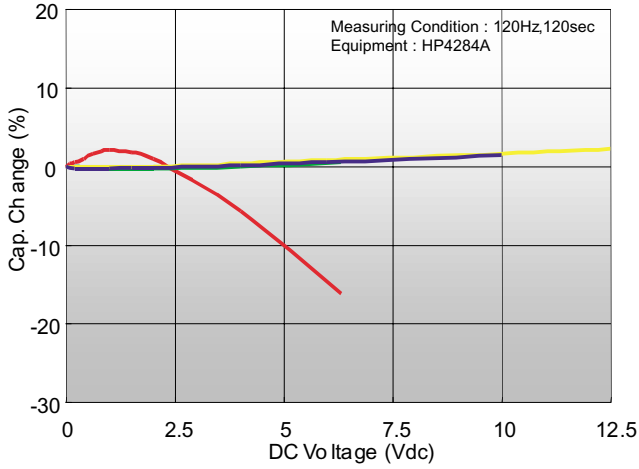

47uF

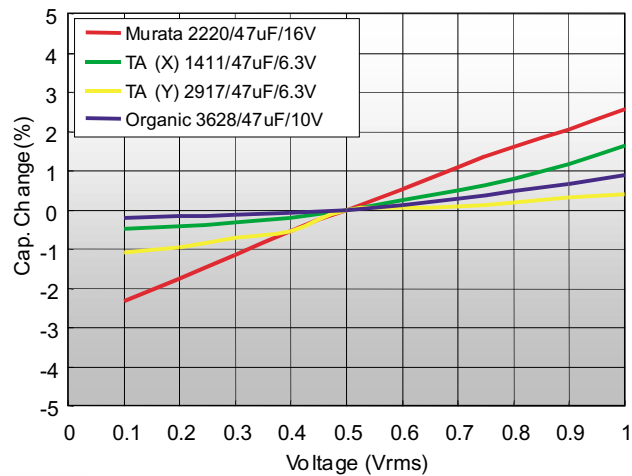
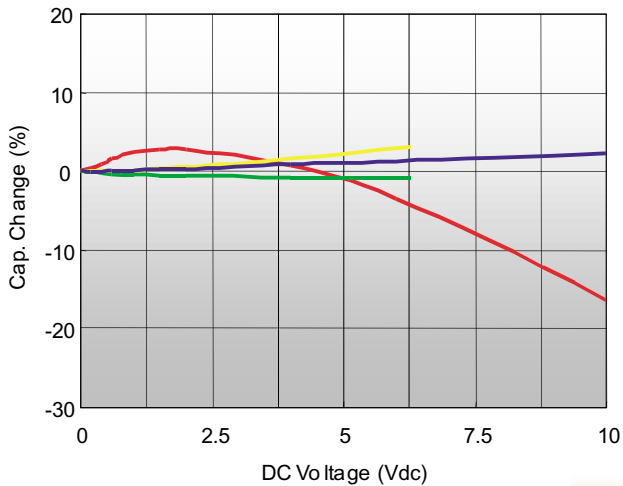

100uF

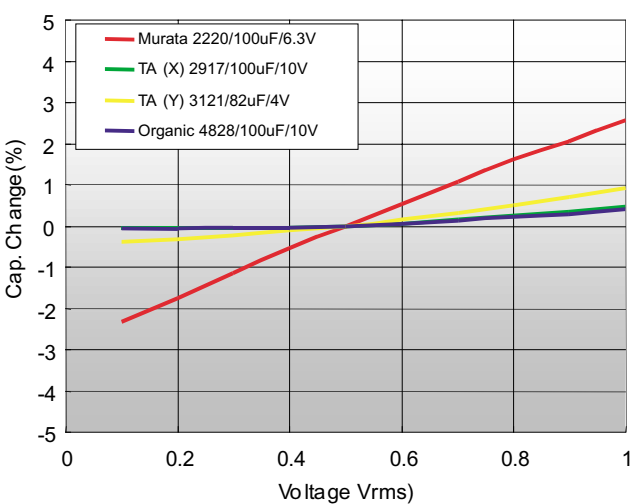
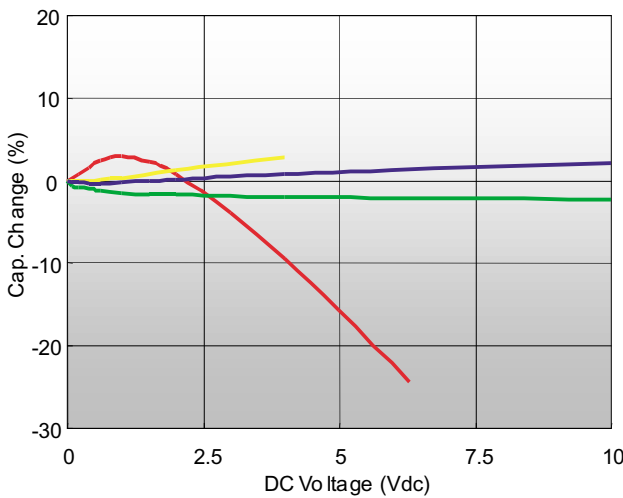

Self Heating -vs- Ripple Current

10uF

Equipment : CVHF - 400

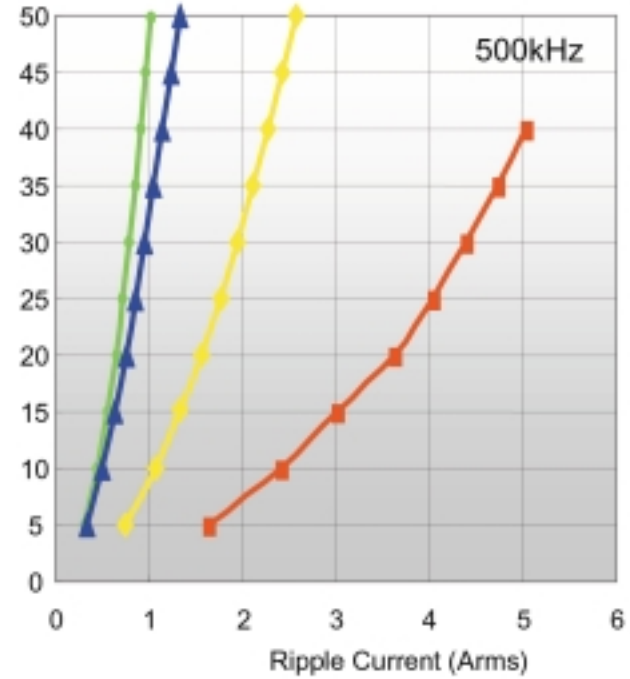
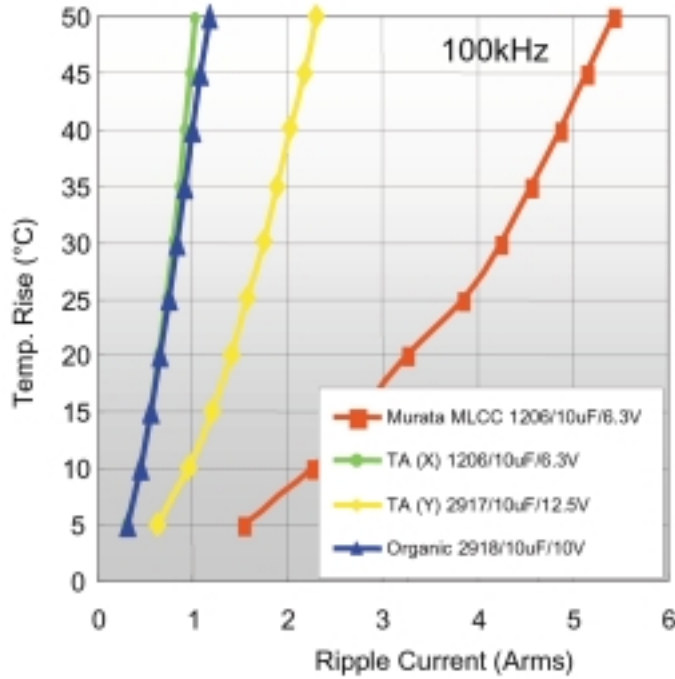

47uF

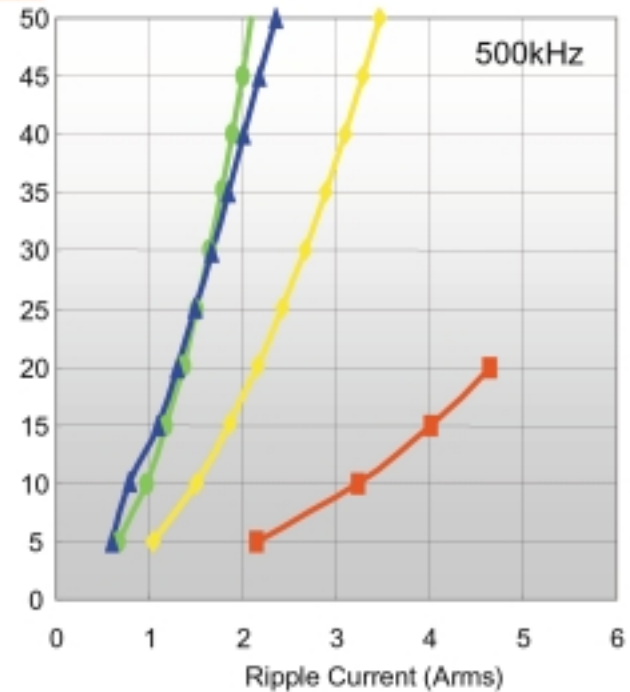
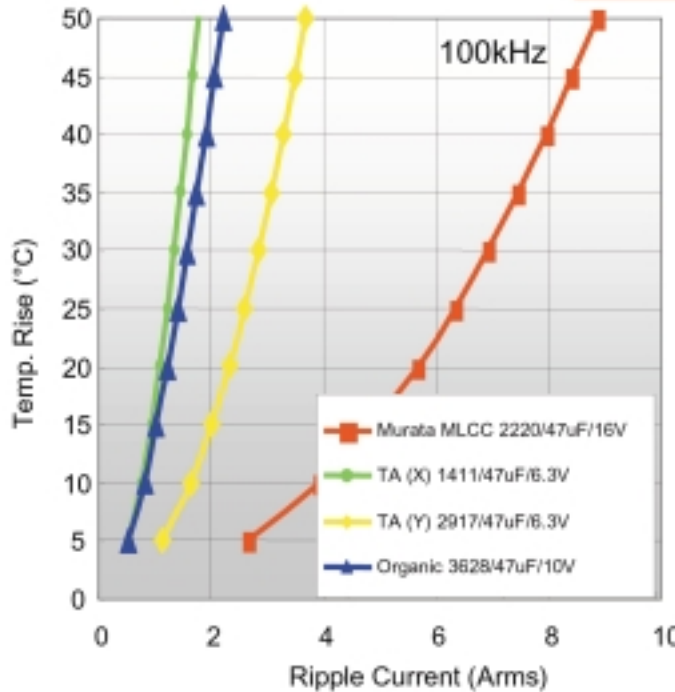



**Murata Electronics
North America, Inc.**

2200 Lake Park Drive
Smyrna, Georgia 30080
Telephone: 770-436-1300
Fax: 770-436-3030
www.Murata.com

©2001 Murata Electronics North America, Inc.

C-24-C