

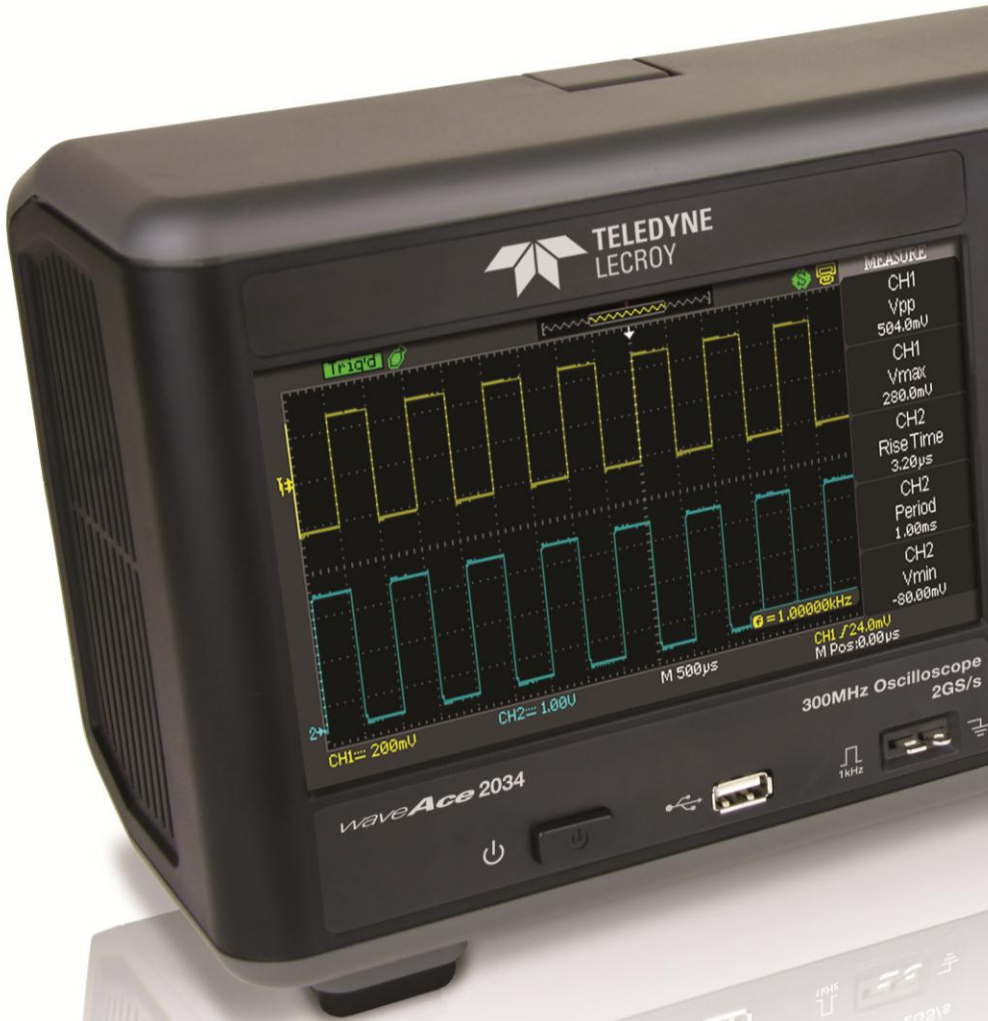

TELEDYNE LECROY
Everywhere you look™



Operator's Manual

WaveAce 1000/2000 Series Oscilloscopes

WaveAce 1000/2000 Series
Oscilloscopes

Operator's Manual

January 2013





TELEDYNE LECROY
Everywhereyoulook™

700 Chestnut Ridge Road
Chestnut Ridge, NY, 10977-6499
Tel: (845) 425-2000
Fax: (845) 578 5985
teledynelecroy.com

© 2013 Teledyne LeCroy, Inc. All rights reserved.

Unauthorized duplication of Teledyne LeCroy documentation materials other than for internal sales and distribution purposes is strictly prohibited. However, clients are encouraged to distribute and duplicate Teledyne LeCroy documentation for their own internal educational purposes.

WaveAce and Teledyne LeCroy are registered trademarks of Teledyne LeCroy, Inc. Windows is a registered trademark of Microsoft Corporation. Other product or brand names are trademarks or requested trademarks of their respective holders. Information in this publication supersedes all earlier versions. Specifications are subject to change without notice.

Warranty

NOTE: THE WARRANTY BELOW REPLACES ALL OTHER WARRANTIES, EXPRESSED OR IMPLIED, INCLUDING BUT NOT LIMITED TO ANY IMPLIED WARRANTY OF MERCHANTABILITY, FITNESS, OR ADEQUACY FOR ANY PARTICULAR PURPOSE OR USE. TELEDYNE LECROY SHALL NOT BE LIABLE FOR ANY SPECIAL, INCIDENTAL, OR CONSEQUENTIAL DAMAGES, WHETHER IN CONTRACT OR OTHERWISE. THE CUSTOMER IS RESPONSIBLE FOR THE TRANSPORTATION AND INSURANCE CHARGES FOR THE RETURN OF PRODUCTS TO THE SERVICE FACILITY. TELEDYNE LECROY WILL RETURN ALL PRODUCTS UNDER WARRANTY WITH TRANSPORT PREPAID.

The oscilloscope is warranted for normal use and operation, within specifications, for a period of three years from shipment. Teledyne LeCroy will either repair or, at our option, replace any product returned to one of our authorized service centers within this period. However, in order to do this we must first examine the product and find that it is defective due to workmanship or materials and not due to misuse, neglect, accident, or abnormal conditions or operation. Teledyne LeCroy shall not be responsible for any defect, damage, or failure caused by any of the following: a) attempted repairs or installations by personnel other than Teledyne LeCroy representatives or b) improper connection to incompatible equipment, or c) for any damage or malfunction caused by the use of non-Teledyne LeCroy supplies. Furthermore, Teledyne LeCroy shall not be obligated to service a product that has been modified or integrated where the modification or integration increases the task duration or difficulty of servicing the oscilloscope. Spare and replacement parts, and repairs, all have a 90-day warranty.

The oscilloscope's firmware has been thoroughly tested and is presumed to be functional. Nevertheless, it is supplied without warranty of any kind covering detailed performance. Products not made by Teledyne LeCroy are covered solely by the warranty of the original equipment manufacturer.

922131-00 Rev A

TABLE OF CONTENTS

Welcome	1
WaveAce 1000/2000 Models	2
Safety Instructions	3
Symbols	3
Precautions.....	4
Operating Environment.....	5
Cooling.....	5
Cleaning.....	5
Power Consumption	6
Power and Ground Connections	6
Standby Power	6
Hardware	7
Front Panel	7
Back and Side Inputs/Outputs.....	8
Basic Controls	9
Powering Up Your WaveAce	9
Front Panel Controls.....	10
Probes	17
Viewing Waveforms	18
Turning On Traces	18
Setting Up the Display	18
Understanding Display Information	19
Auto Setup.....	21
Vertical Settings and Channel Controls	23
Choosing Coupling.....	23
Limiting Bandwidth	24
Adjusting Sensitivity	25
Setting Probe Attenuation.....	26
Inverting Waveforms.....	26
Setting the Digital Filter.....	27
Unit and Skew Settings.....	28
Acquisition Types	29
Sin x / x	30
Mode Selection	31
Sampling Rate.....	31
Acquiring Waveforms.....	32

Changing the Timebase	32
Zooming Waveforms	32
Triggering.....	34
Trigger Types	34
Edge Triggering.....	34
Pulse Triggering	35
Video Triggering	36
Slope Triggering.....	37
Alternative Triggering.....	38
Analyzing Waveforms	39
Measuring with Cursors	39
Parameter Measurements	43
Waveform Math	49
FFT Spectrum Analyzer	51
Creating Reference Waveforms	53
Save and Recall	54
Saving and Recalling Oscilloscope Settings	54
Saving and Recalling Waveforms.....	57
Saving and Printing Waveform Pictures	59
Saving Data as a .CSV File	61
Recalling Factory Settings.....	62
Using the SAVE ALL Screen	66
Utilities	69
Utility Menu	69
Print Setup.....	78
Updating the System Software.....	80
Using Pass/Fail.....	82
Using Record	85
Setting and Displaying the Date/Time.....	89
Reference.....	90
Using WaveStudio to Remotely Connect to the WaveAce	90
WaveAce Specifications	92
Certifications	92
Contact Teledyne LeCroy.....	96
Index.....	97

Welcome

Thank you for purchasing a Teledyne LeCroy WaveAce product. This Operator's Manual includes important safety and installation information for your WaveAce 1000/2000 Oscilloscope, along with operating procedures for capturing, viewing, and analyzing waveforms.

This WaveAce Operator's Manual is organized in the following manner:

- Hardware (physical features) and Basic Controls
- Viewing Waveforms, includes instructions on setting up the Display
- Vertical and Horizontal Settings, Sampling Modes, and Triggering
- Analyzing Waveforms using parameter Measurements, Math functions, and Reference Waveforms
- Saving and Recalling oscilloscope setups, waveforms, .CSV files, and waveform images. This section also provides procedures to recall factory settings.
- Reference section including certification and contact information.

When oscilloscope is delivered, verify that all items on the packing list or invoice copy have been shipped to you. Contact your nearest Teledyne LeCroy customer service center or national distributor if anything is missing or damaged. If you do not contact us immediately, we cannot be responsible for replacement. If you have any problems with your product, please refer to **Contact Teledyne LeCroy for Support** at the end of this *Operator's Manual*. You can also refer to additional support materials at teledynelecroy.com.

We truly hope these materials provide increased comprehension when using Teledyne LeCroy's fine products.

Sincerely,



David C. Graef

Teledyne LeCroy Corporation
Vice President and Chief Technology Officer

WaveAce 1000/2000 Models

WaveAce 1000/2000 models are available in **two** and **four channel** versions. The following table shows the two and four channel models and their rated bandwidths.

Two Channel WaveAce Models	Four Channel WaveAce Models
1001 - 40 MHz	2004 - 70 MHz
1002 - 60 MHz	2014 - 100 MHz
1012 - 100 MHz	2024 - 200 MHz
2002 - 70 MHz	2034 - 300 MHz
2012 - 100 MHz	
2022 - 200 MHz	
2032 - 300 MHz	

Safety Instructions

This section contains instructions that must be observed to keep the instrument operating in a correct and safe condition. You are required to follow generally accepted safety procedures in addition to the precautions specified in this section.

The overall safety of any system incorporating this instrument is the responsibility of the assembler of the system.

Symbols

These symbols appear on the instrument's front or rear panels and in its documentation to alert you to important safety considerations.



CAUTION of damage to instrument, or **WARNING** of hazard to health. Attend to the accompanying information to protect against personal injury or damage. Do not proceed until conditions are fully understood and met.



WARNING. Risk of electro-shock.

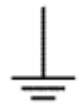

Measurement ground connection.



Safety (protective) ground connection.



Alternating Current.

Precautions

- **Use proper power cord.** Use only the power cord shipped with this instrument and certified for the country of use.
- **Maintain ground.** This product is grounded through the power cord grounding conductor. To avoid electric shock, connect only to a grounded mating outlet.
- **Connect and disconnect properly.** Do not connect/disconnect probes or test leads while they are connected to a voltage source.
- **Observe all terminal ratings.** Do not apply a voltage to any input (C1, C2, C3, C4 or EXT) that exceeds the maximum rating of that input. Refer to the front of the oscilloscope for maximum input ratings.
- **Use only within operational environment listed.** Do not use in wet or explosive atmospheres.
- **Use indoors only.**
- **Keep product surfaces clean and dry.**
- **Do not block the cooling vents.** Leave a minimum six-inch (15 cm) gap between the instrument and the nearest object. Keep the underside clear of papers and other objects.
- **Do not remove the covers or inside parts.** Refer all maintenance to qualified service personnel.
- **Do not operate with suspected failures.** Do not use the product if any part is damaged. Obviously incorrect measurement behaviors (such as failure to calibrate) might indicate impairment due to hazardous live electrical quantities. Cease operation immediately and sequester the instrument from inadvertent use.

Operating Environment

Temperature: 10 to 40 °C.

Humidity: Maximum relative humidity 80 % for temperatures up to 31 °C decreasing linearly to 50 % relative humidity at 40 °C (or at the upper operational temperature limit).

Altitude: Up to 10,000 ft (3,048 m) at or below 25 °C.

Note: Direct sunlight, radiators, and other heat sources should be taken into account when assessing the ambient temperature.

Cooling

The instrument relies on forced air cooling with internal fans and vents. Take care to avoid restricting the airflow to any part of the oscilloscope. Around the sides and rear, leave a minimum of 15 cm (6 inches) between the instrument and the nearest object. At the bottom, the oscilloscope feet (up or down) provide adequate clearance.



CAUTION. Do not block oscilloscope vents. Always keep the area beneath the oscilloscope clear of paper and other items.

The instrument also has internal fan control circuitry that regulates the fan speed based on the ambient temperature. This is performed automatically after start-up.

Cleaning

Clean only the exterior of the oscilloscope using a damp, soft cloth. Do not use harsh chemicals or abrasive elements. Under no circumstances submerge the instrument or allow moisture to penetrate it. Avoid electric shock by unplugging the power cord from the AC outlet before cleaning.



CAUTION. Do not attempt to clean internal parts. Refer to qualified service personnel.

Power Consumption

< 50 Watts for all models (depending on accessories installed - probes, USB devices, etc.).

Power consumption in Standby Mode: < 5 Watts.

Power and Ground Connections

The instrument is provided with a 10A/250V 18AWG rated grounded cord set containing a molded three-terminal polarized plug and a standard IEC-60320 (Type C13) connector for making line voltage and safety ground connections.

The AC inlet ground is connected directly to the frame of the instrument. For adequate protection against electric shock, connect to a mating outlet with a safety ground contact.



WARNING. Interrupting the protective conductor inside or outside the oscilloscope, or disconnecting the safety ground terminal, creates a hazardous situation. Intentional interruption is prohibited.

Standby Power



The Power (Standby) button controls the operational state of the oscilloscope. Press the button to switch the instrument On or into Standby mode (Off).

Always use the Power button to execute a proper shut down process and preserve settings before powering down.

Powering off does not disconnect the oscilloscope from the AC power supply. The only way to fully power down the instrument is to shut down then unplug the AC power cord from the outlet.

We recommend unplugging the instrument if it will be unused for a long period of time.

Hardware

Front Panel

The WaveAce 1000/2000 Series oscilloscopes provide an easy-to-use front panel. The control buttons are logically grouped.

NOTE: While the following picture is from the 4 Channel version, besides the extra channels, button and knob locations are essentially the same on the 2 Channel model.

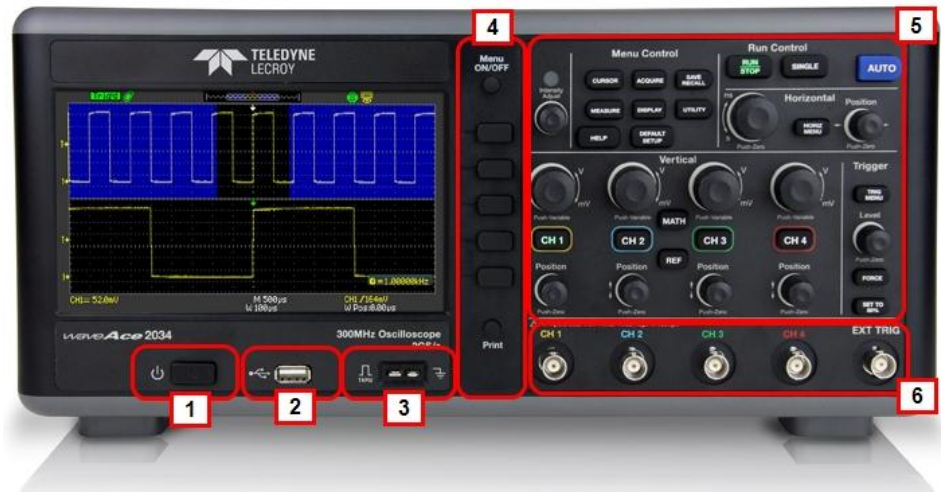

Front panel buttons and knob locations on 4 Channel WaveAce Oscilloscopes. Layout is very similar on 2 Channel models

Previously numbered front panel buttons and knob locations correspond with the following explanations.

1. Power Button
2. Front USB (Type A) Connector
3. 1 KHz and Ground Probe Connectors
4. Menu On/Off, Menu Option, and Print Buttons
5. Front Panel Controls
6. Channel and External Trigger Input Connectors

Back and Side Inputs/Outputs

The following image shows back panel connection locations for the 4 Channel models.



Back panel connection locations on the 4 Channel WaveAce Oscilloscope.

Previously numbered front panel buttons and knob locations on 4 Channel models correspond with the following explanations.

1. Pass/Fail Output
2. RJ-45 Connector

NOTE: For more information, see **Using WaveStudio to Remotely Connect to your WaveAce Oscilloscope** (on page 90).

3. Rear USB (Type B and Type A, respectively) Connectors. Use the Type B connector to attach a printer to your instrument. The Type A connector is designated for memory stick use just like the one on **the** Front Panel.

NOTE: If you simultaneously connect separate memory sticks to both the front and back Type A connectors, the WaveAce defaults to only using the one attached to the front connector.

4. Power Shutoff Switch and Input Connector

NOTE: The WaveAce 1000 model has a Power Input Connector and no Power Shutoff Switch on the left side (facing) of the instrument instead of the back.

5. Security Lock Receptacle

Basic Controls

Powering Up Your WaveAce

1. Power On the oscilloscope by pressing the power button (located on the lower front of the 2000 models and top left on the 1000 models, when facing the instrument).



2. The Teledyne LeCroy **Splash** screen is shown. Press any key to continue (or, after a brief period the grid display is shown).
3. The **Grid Display** is shown.

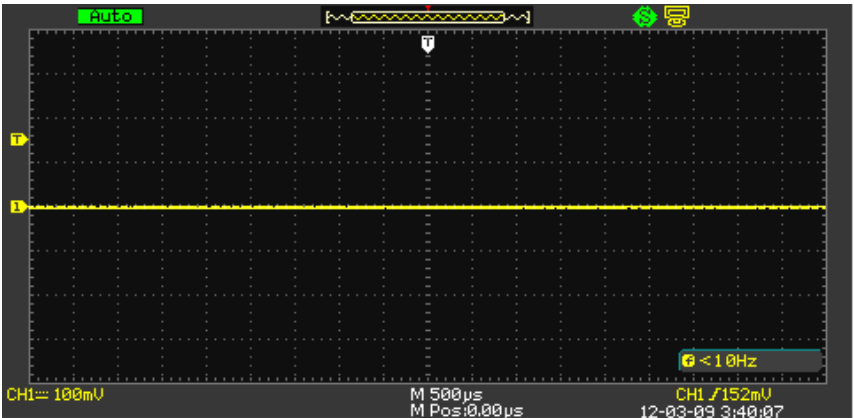

NOTE: The screen size varies slightly between all WaveAce Series Oscilloscopes. Therefore, the screen-shots in this documentation may look more narrow or wide than they appear on your specific model. However, the screens are all functionally the same and the slight differences have no affect when following these instructions.

Front Panel Controls

Note: While the following pictures are from the 4 Channel version, besides the extra channels, button and knob locations are essentially the same on the 2 Channel model.



Intensity/Adjust Knob



- **Intensity/Adjust knob** - You can use the **Adjust** knob with many functions, such as adjusting the holdoff time, moving cursors, setting the pulse width, setting the video lineage adjusting the upper and lower frequency limits, adjusting X and Y masks when using the Pass/Fail function, etc. You can also turn the **Adjust** knob to adjust the storage position of setups, waveforms, pictures when saving/recalling and to select menu options.

Menu Control, Option and Print Buttons

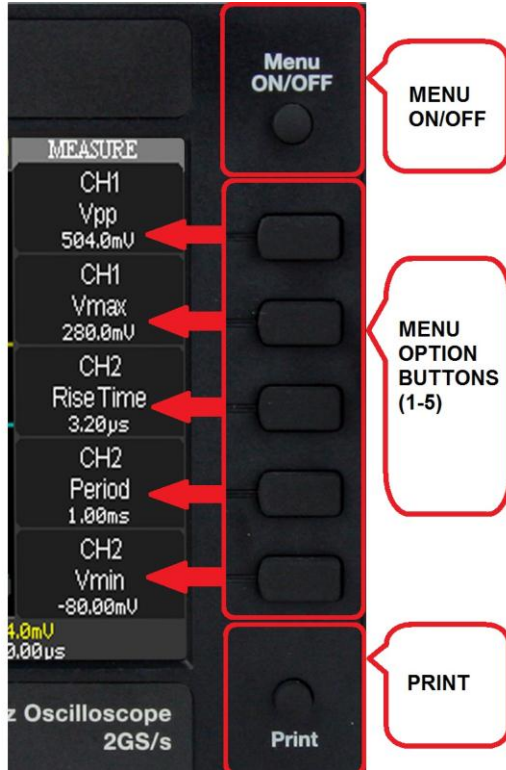

- **MENU ON/OFF** - Press to toggle the last-displayed menu On/Off.
- **Menu Option buttons (1-5)** - Press to choose menu options. Press a menu option button adjacent to your selection.
- **Print** - Press to save the current waveform to an attached USB memory device or print a picture (screen shot) to a USB-connected printer. You can set up the save/print options using the **Save/Recall → Picture** settings. For more information, refer to **Saving and Printing Waveform Pictures** (on page 59).

Menu Control Buttons



- **CURSORS** - Press to turn on the cursors and display the **Cursor** menu. You can use the **Cursor** menu to set the Cursor Mode (**Auto, Off, Manual, Track**). When Cursors are on (**CURSORS** button is lit), turn the **Adjust knob** to position the cursors. See **Measuring with Cursors** (on page 39) for more information.
- **ACQUIRE** - Press to display **Acquire** menu. You can use the **Acquire** menu to set the acquisition Sampling Mode (**Sampling, Peak Detect, Average**). See **Acquisition Types** (on page 29) for more information.
- **SAVE/RECALL** - Press to display the **Save/Recall** menu. You can use the **Save/Recall** menu to save and recall up to 20 oscilloscope setups or waveforms in internal memory (up to 20 waveforms) or on a USB memory device (limited by memory capacity of USB device). You can also use it to recall the default factory settings, to save waveform data as a comma-delimited file (.CSV), and to save or print the displayed waveform image. See **Saving and Recalling Oscilloscope Settings** (on page 54) for more information.
- **MEASURE** - Press to display a menu of measurement parameters. The **Display Type** must be set to **YT** mode. For more information on measurement parameters, refer to **Parameter Measurements** (on page 43).
- **DISPLAY** - Press to open the **Display** menu. You can use the **Display** menu to set grid and waveform display styles, and persistence. See **Setting Up the Display** (on page 18) for more information.
- **UTILITY** - Press to open the **Utility** menu. You can use the **Utility** menu to configure WaveAce features, such as sound, language, counter, etc. You can also view system status and update software. See **Utility Menu** (on page 69) for more information.

General Control Buttons



Note: Exact Help, Default Setup, and AUTO button locations vary on 4 and 2 Channel models.

- **HELP** - Displays context-sensitive online help. Press Help, and then another front panel button and information pertaining to the selected button is shown.
- **DEFAULT SETUP** - Press to reset the oscilloscope's settings to the default factory configuration. For a list of default settings, see **Recalling Factory Settings** (on page 62).
- **AUTO** - Press to have the oscilloscope automatically identify the type of waveform and adjust the controls to produce a usable display of the input signal. When you press the AUTO front panel button, the Auto Set menu opens. You can use this menu to display multiple-cycle signals, a single-cycle signal, the rising edge, the falling edge or recall the previous setup.

Run Control Buttons

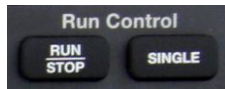

- **SINGLE** - Press to acquire a single waveform. Each time you press the **SINGLE** button, the oscilloscope acquires another waveform. When the oscilloscope detects a trigger it completes the acquisition and stops.
- **RUN/STOP** - Press when you want the oscilloscope to acquire waveforms continuously. Press **RUN/STOP** again to stop the acquisition.

See the Acquiring Waveforms section of **Acquisition Types** (on page 29) for more information.

Vertical Controls



- **Volts/Div knobs** (CH1-4, pictured) - Turn to adjust the volts/division setting (vertical gain) of the corresponding channel (CH1-4). Press the knob to toggle between fine (variable) and coarse (fixed) adjustments. See **Vertical Settings and Channel Controls** (on page 23) for more information.
- **Channel buttons** (CH1-4) - Press a channel button (CH1-4) to turn that channel ON or OFF and open the **Channel** menu for that channel. You can use the **Channel** menu to set up a channel. When the channel is ON, the channel button is lit.
- **Vertical Position knobs** (CH1-4) - Turn to adjust the vertical position of the corresponding channel (CH1-4). Press to set the vertical position to zero.
- **REF** - Press to display the **Ref Wave** menu. You can use this menu to save and recall two reference waveforms (REFA and REFB) in internal memory. See **Creating Reference Waveforms** (on page 53) for more information.
- **MATH** - Press to display the **Math** menu. The **Math** menu provides numerous mathematical functions as explained in **Waveform Math** (on page 49).

Horizontal Controls



- **Horizontal Position knob** - Turn to adjust the horizontal position of all channels and math waveforms (the position of the trigger relative to the center of the screen). The resolution of this control varies depending on the timebase setting. Press to set the horizontal position to zero.
- **HORI MENU** - Press to display the **Horizontal** menu. You can use the **Horizontal** menu to display the waveform and to zoom a segment of a waveform.
- **Time/Div knob** - Turn to change the horizontal time scale to magnify or compress the waveform. When Window Zone is enabled, it changes the width of the Window Zone by changing the window timebase. When the Time/Div control is set to 100 ms/div or slower and the trigger mode is set to Auto, the oscilloscope enters the scan acquisition mode. In this mode, the waveform display updates from left to right. There is no trigger or horizontal position control of waveforms during scan mode.

NOTE: Pressing the Horizontal **Time/Div** front panel knob (**Push-Zoom**) toggles between **Delayed ON/OFF** settings. As explained in **Zooming Waveforms** (on page 32), with Delay set to ON, the display provides a split-screen layout where an upper trace shows the actual waveform with a shaded, mask-like portion covering the non-zoomed portion of the waveform; the lower trace displays the actual zoom segment.

Trigger Controls



- **TRIG MENU** - Press to display the **Trigger** menu. You can use the **Trigger** menu to set the trigger type (**Edge, Pulse, Video, Slope, Alternative**) and trigger settings.
- **SET TO 50%** - Press to stabilize a waveform quickly. The oscilloscope can set the Trigger Level to be halfway between the minimum and maximum voltage levels automatically. This is useful when you connect a signal to the EXT TRIG connector and set the trigger source to Ext or Ext/5.
- **FORCE** - Press to complete the current waveform acquisition whether the oscilloscope detects a trigger or not. This is useful for SINGLE acquisitions and Normal trigger mode.
- **LEVEL** - Turn to select the trigger threshold level. Press the **Level** front panel knob to set the trigger level to zero.

See **Trigger Types** (on page 34) for more information.

Probes

Teledyne LeCroy provides a passive probe for each WaveAce oscilloscope channel.

Passive probes must be compensated to flatten overshoot. This is accomplished by means of a trimmer on the probe body.

1. Attach the connector end of your probe to any channel.
2. Connect the probe end to the CAL output connector at the front of the oscilloscope.
3. Adjust the trim pot on the probe body until the square wave is as flat as possible.
4. Set the Probe option attenuation to 10X by pressing the **Channel** button and then the **Probe** menu button.
5. Set the switch to 10X on the probe.
6. Attach the probe tip to the **PROBE COMP~3V** connector and the reference lead to the **PROBE COMP Ground** connector. Press the corresponding channel button, and then push the **AUTO** button.
7. Check the shape of the displayed waveform as follows:

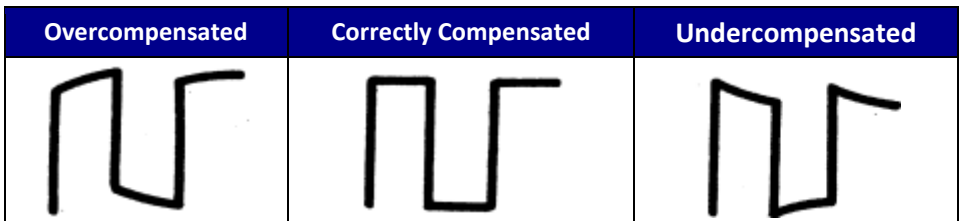

See **Setting Probe Attenuation** (on page 26) in the **Vertical Settings and Channel Controls** section for more information.

Viewing Waveforms

Turning On Traces

Turn on a channel trace by pressing the channel front panel button - CH1 or CH2 (or CH3 or 4 on 4 channel models). When you turn on a channel, the **Channel** menu opens. You can then set up the vertical settings and controls for the channel. When the channel is ON, the channel button is lit.

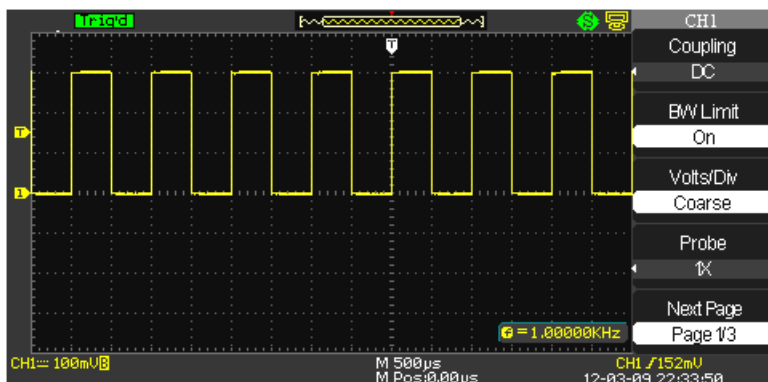

NOTE: Turn a trace off by pressing the channel front panel button again.

Setting Up the Display

You can access the Display menu pressing the **DISPLAY** front panel button.

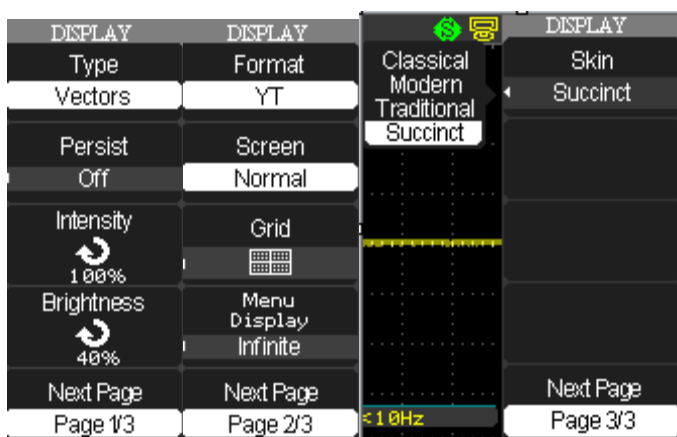



Display Menu Pages 1/3, 2/3, and 3/3 and their options are described as follows:



1. **Type - Vectors** fill the space between adjacent sample points in the display. **Dots** displays sample points directly.
2. **Persist** - Sets the length of time (1 sec, 2 sec, 5 sec, Infinite) each displayed sample point remains displayed.
3. **Intensity** - Turn the **Universal** front panel knob to set the Intensity.
4. **Brightness** - Turn the **Universal** front panel knob to set the screen brightness.
5. **Format** - Choose between **YT** format and **XY** format.
6. **Screen** - Set to Normal mode or Inverted color display mode.
7. **Grid** - Display grids and axes, turn off grids, or turn off grids and axes.
8. **Menu Display** - Set the length of time the menus are shown on screen (2 seconds, 5 seconds, 10 seconds, 20 seconds, or Infinite).
9. **Skin** - You can change the color of the software interface by selecting **Classical** (default), **Modern**, **Traditional**, and **Succinct** skin options.

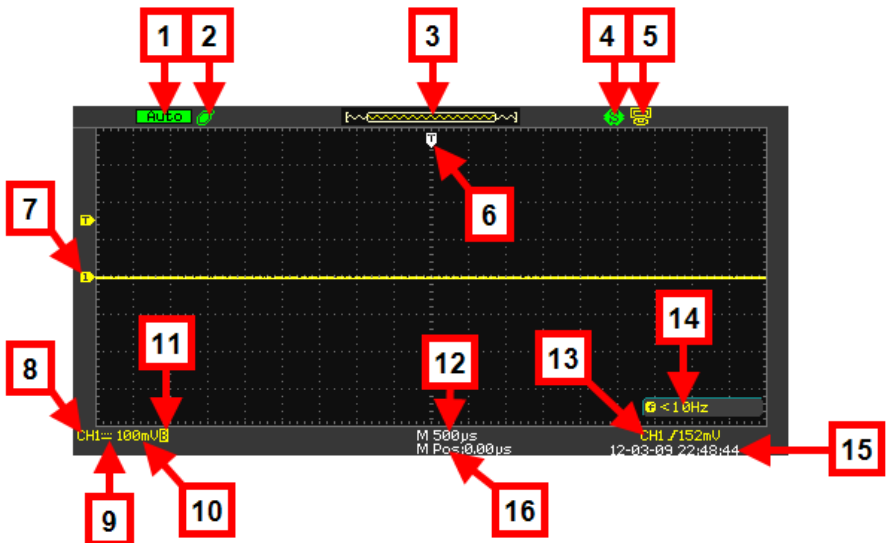

Understanding Display Information

The grid area contains several indicators to help you understand the display. Indicators are coded to the channel colors).



1. **Trigger Status** - The following states are shown as highlighted text on this part of the screen.
 - **Armed** - The oscilloscope is acquiring pre-trigger data. All triggers are ignored in this state.
 - **Ready** - The oscilloscope is ready to trigger.
 - **Trig'd** - The oscilloscope has found a trigger and is acquiring the post-trigger data.
 - **Stop** - The oscilloscope has stopped acquiring waveform data. Shown in red highlight.
 - **Acq. Complete** - The oscilloscope has completed a Single Sequence acquisition.
 - **Auto** - The oscilloscope is in Auto Mode and is acquiring waveforms in the absence of triggers.
 - **Scan** - The oscilloscope is acquiring and displaying waveform data continuously in Scan Mode.
2. **USB Memory Device** - Indicates whether the USB Memory Device is inserted in the USB Port.
 - When a USB Memory Device is not inserted in the USB Port the area is blank.
 -  USB Memory Device is inserted in the USB Port (as shown previous).
 - When plugging in or removing a USB Memory Device, a message is briefly shown on the grid display as **USB Flash Drive Plug In!** and **USB Flash Drive Pull Out!**, respectively.
3. **Waveform Preview Display** - This small portion at the top of the screen shows how much of the captured waveform is currently appearing on the display.

NOTE: Show the full waveform by stopping the trigger and turning the Time/Div button to the left (increasing the amount of time shown on the display).
4. **Print Key** - Indicates whether the **Print Key** option is set to **Print Picture** or **Save Picture**.
 -  **Print Key** option set to **Save Picture** (as shown previous).
 -  **Print Key** option set to **Print Picture**

5. **Back USB** - Indicates whether the Back USB option is set to **Computer** or **Printer**.
 -  **Back USB** option set to **Computer** (as shown previous).
 -  **Back USB** option set to **Printer**
6. **Horizontal Trigger Position Marker** - Shows the horizontal trigger position.
7. **Display Markers** (Zero Volts Level) - Show the ground reference points of the displayed waveforms. If there is no marker, the channel is not displayed.
8. **Display Signal Source**
9. **Signal Coupling symbol**
10. **Volts/Division**
11. Indicates whether the **bandwidth limiting filter** is **On** or **Off**. The **B** icon indicates the filter is **On**.
12. Main **timebase setting** (a Window timebase setting is also displayed when applicable).
13. **Trigger Source**
14. **Frequency Counter** of Trigger Signal
15. **Trigger type** and level indicator
16. **Horizontal Trigger Position Readout** - Displays the waveform's horizontal position in time (seconds).

Auto Setup



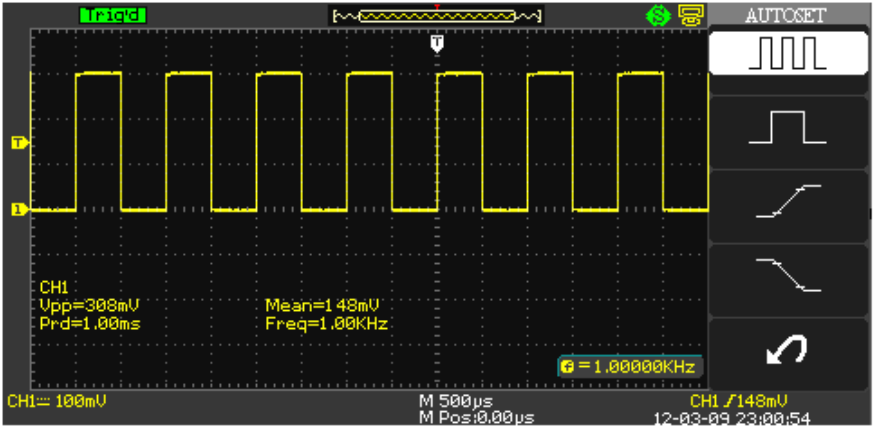

The **Auto Setup** function identifies the waveform type and automatically adjusts controls to produce a usable input signal display.

Four Auto Setup waveform options are available: **Multi-Cycle**, **Single-Cycle**, **Rising Edge**, and **Falling Edge**.

Press the **AUTO** front panel button, and then press the menu option button adjacent to the desired waveform as follows:



Note: Use the bottom waveform menu button to Undo an applied Auto Setup.

Option	Description
 (Multi-cycle)	Auto set the screen and display several cycle signal.
 (Single-cycle)	Set the screen and auto display single cycle signal.
 (Rising edge)	Auto set and show the rising time.
 (Falling edge)	Auto set and show the falling time.
 (Undo Setup)	Causes the oscilloscope to recall the previous setup.

Vertical Settings and Channel Controls

When you turn a channel trace ON, the **Channel** menu opens. The **Channel** menu page shown (1/3, 2/3, or 3/3) is always based on the most recent trace activated.

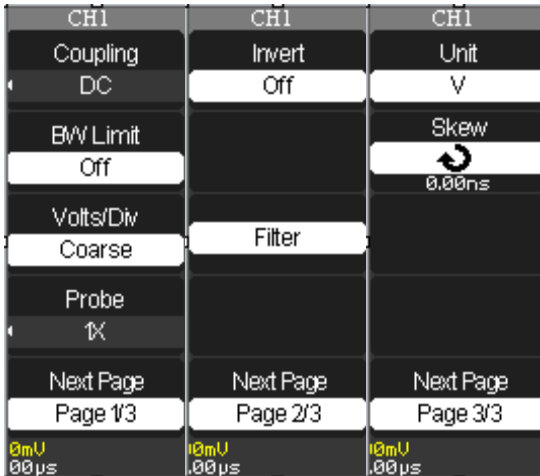

Choosing Coupling

You can choose one of these input coupling modes:

- **DC** - Passes both AC and DC components of the input signal.
- **AC** - Blocks the DC component of the input signal and attenuates signals below 10 Hz.
- **GND** - Disconnects the input signal. Use GND coupling to display a zero-volt waveform. Internally, the channel input is connected to a zero-volt reference level.

NOTE:

- If the channel is set to DC coupling, you can quickly measure the DC component of the signal by simply noting its distance from the ground symbol.
- If the channel is set to AC coupling, the DC component of the signal is blocked allowing you to use greater sensitivity to display the AC component of the symbol.

WaveAce 1000/2000

1. Choose an input coupling mode. Turn on the desired channel by pressing the appropriate channel button - CH1 or CH2 (or CH3 or 4 on 4 channel models).
2. Now, press the **Coupling** option button on page 1/2 of the channel menu, and then select a coupling mode from the menu.

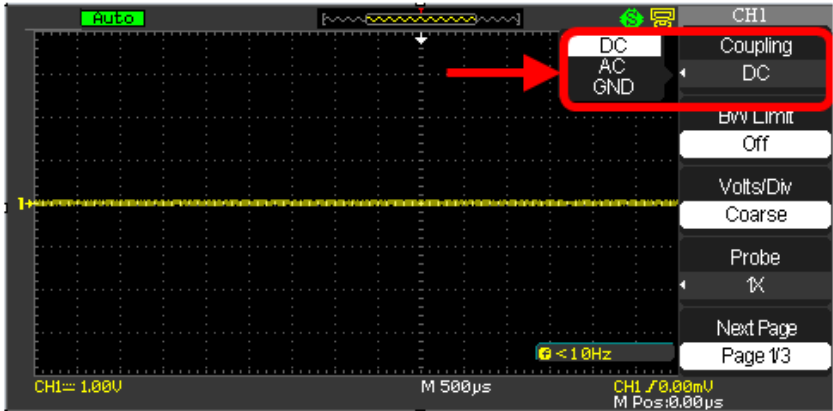

Limiting Bandwidth

You can limit the bandwidth to reduce display noise. When you turn Bandwidth Limit ON, the Bandwidth Limit value is set to 20 MHz. It also filters the signal to reduce noise and other unwanted high frequency components.

NOTE: The oscilloscope vertical response rolls off slowly above its bandwidth; or, above 20 MHz when the Bandwidth Limit is set to ON. Therefore, the FFT spectrum can show valid frequency information higher than the oscilloscope bandwidth. However, the magnitude information near or above the bandwidth will not be accurate.

1. Turn the Bandwidth Limit ON by activating the specific channel. Press the desired channel button - CH1 or CH2 (or CH3 or 4 on 4 channel models).
2. Now, press the **BW Limit** option button on page 1/2 of the channel menu, and then select **On**.

A highlighted **B** icon at the lower-left of the display indicates bandwidth limitation is on.

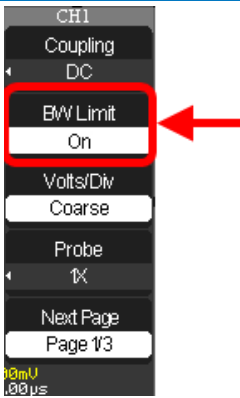

Adjusting Sensitivity

You can set the sensitivity of the **Volts/Div** using the front panel knob. When the sensitivity is **Coarse** (or fixed - the default setting), the gain adjustment is set to 1-2-5 increments from 2 mV/div, 5 mV/div, 10 mV/div to 5 V/div. Pushing the Volts/Div knob sets the sensitivity to **Fine** (variable), and changes the resolution to small steps between the coarse settings.

NOTE: The vertical scale readout displays the actual **Volts/Div** setting when **Fine**(variable) is selected. Changing the setting to **Coarse** (fixed) does not change the vertical scale until the **Volts/Div** control is adjusted.

1. Set the sensitivity of the Volts/Div front panel knob by turning on the specific channel. Press the desired channel button - CH1 or CH2 (or CH3 or 4 on 4 channel models).

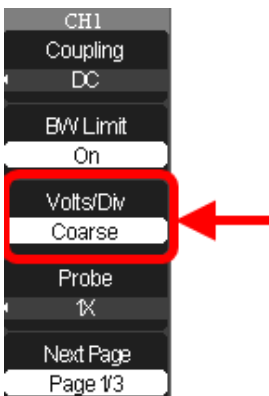

2. Now, press the **Volts/Div** option button on page 1/3 of the channel menu, and then select **Coarse (fixed)** or **Fine (variable)**.

Setting Probe Attenuation

Probes are available with various attenuation factors affecting the vertical scale of the signal. Push the Channel button, and then the Probe menu option button. Attenuation options for **1X**, **10X**, **50X**, **100X**, **500X**, and **1000X**.

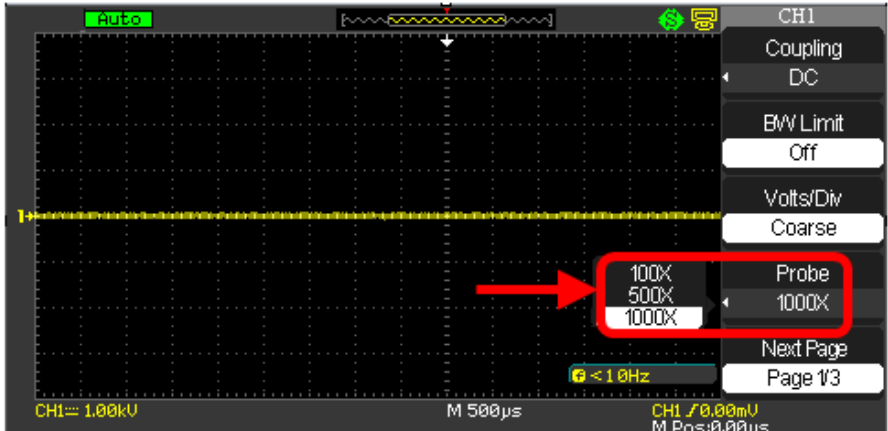

NOTE:

- The default setting for the Probe option is 1X.
- Be sure that the Attenuation switch on the probe matches the Probe option in the oscilloscope. Switch settings are 1X and 10X.
- When the Attenuation switch is set to 1X, the probe limits the bandwidth of the oscilloscope to 10MHz. To use the full bandwidth of the oscilloscope, be sure to set the switch to 10X.

Inverting Waveforms

Use the following steps to invert your waveform.



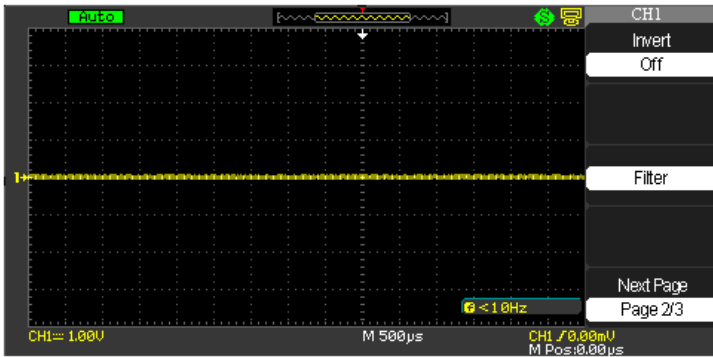

1. Invert the waveform by turning on the specific channel. Press the desired channel button - CH1 or CH2 (or CH3 or 4 on 4 channel models).
2. Now, on the channel menu, press the **Next Page** option button, showing page 2/3.



3. Press the **Invert** option button on page 2/3, and then select **On**.

Setting the Digital Filter

You can choose from the following digital filter types:

-  Low Pass Filter (LPF)
-  High Pass Filter (HPF)
-  Band Pass Filter (BPF)
-  Band Stop Filter

Use the following steps to set the digital filter.

1. Turn on the digital filter by pressing the desired channel button - CH1 or CH2 (or CH3 or 4 on 4 channel models).
2. On the channel menu, press the **Next Page** option button, showing page 2/3.
3. Press the **Filter** option button on page 2/3. The **Filter** menu opens.

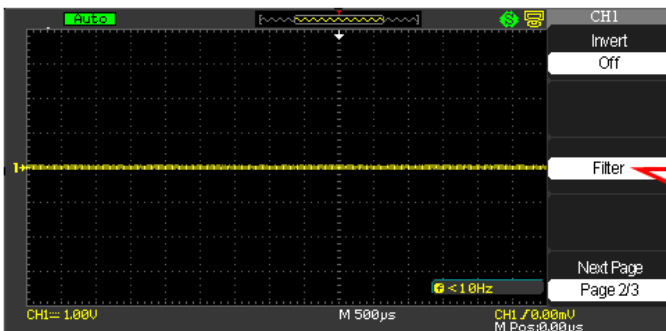

Use the Filter option button to access the Filter menu

4. Press the **Filter** option button and select **On**.

5. Press the **Type** option button and select a digital filter type.

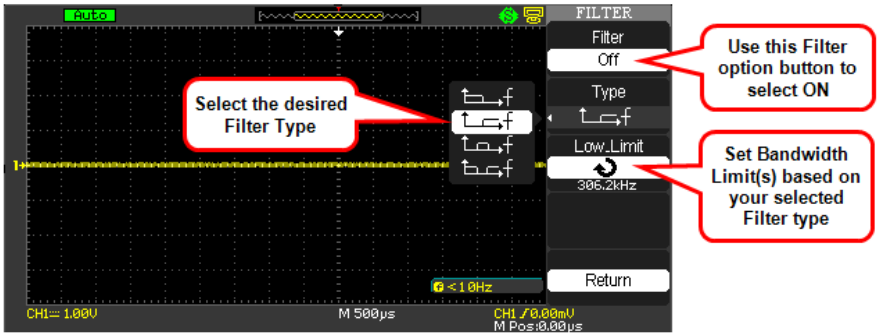

6. Press the **Upp. Limit** option button and turn the **Adjust** front panel knob to set the Upper limit.
7. Press the **Low. Limit** option button and turn the **Adjust** front panel knob to set the Lower limit.

NOTE: If you select the Low Pass Filter (LPF) type, you can only set an Upper Limit. If you select the High Pass Filter (HPF) type, you can only set a Lower Limit. For both Band Pass Filter (BPF) and Band Stop Filter, you can set both Upper and Lower Limits.

Unit and Skew Settings

On the channel menu, press the **Next Page** option button, showing page 3/3. This menu allows you to set your desired Unit and Skew values.

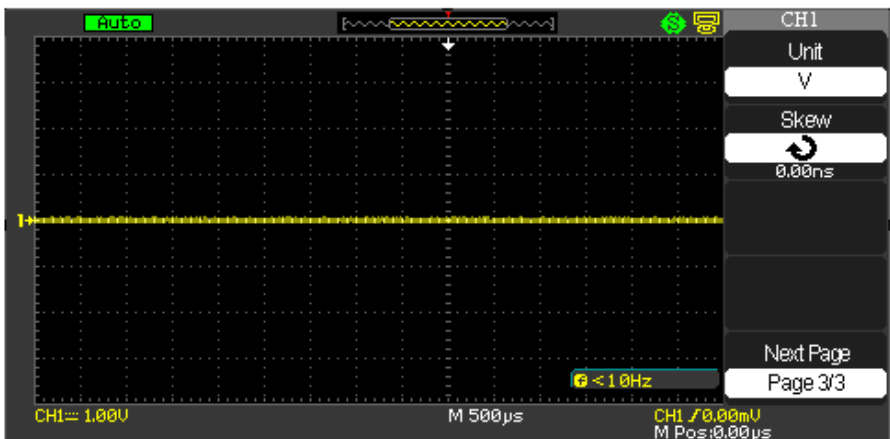

1. Pressing the Unit option button selects between **V** (Volts) and **A** (Amperes) values.
2. Pressing the **Skew** option button enables the **Adjust** front panel knob to set your desired value.

Acquisition Types

When you acquire a signal, the oscilloscope converts it into a digital form and displays a waveform. The acquisition sampling mode defines how the signal is digitized and the timebase setting affects the time span and level of detail in the acquisition. You can change the Sampling modes by pressing the ACQUIRE front panel button.

There are three basic acquisition types:

- **Error! Bookmark not defined.Sampling**- samples the signal in evenly-spaced intervals to construct the waveform. You can use this type to reduce random noise. This type does not acquire rapid variation in the signal that may occur between samples. This can result in narrow pulses being missed. In this case, use **Peak Detect** to acquire data.
- **Error! Bookmark not defined.Peak Detect** - captures the maximum and minimum values that occur in a signal. It finds the highest and lowest record points over many acquisitions. The oscilloscope can acquire and display narrow pulses, which may otherwise have been missed in Sampling mode. Noise appears higher in this mode.
- **Average** - acquires up to 256 waveforms, averages them, and displays the resulting waveform. This type can be used to reduce random noise.

WaveAce 1000/2000

Use the following steps to choose a sampling type.

1. Press the **ACQUIRE** front panel button.
2. On the **Acquire** menu, press the **Acquisition** option button and select a sampling type.

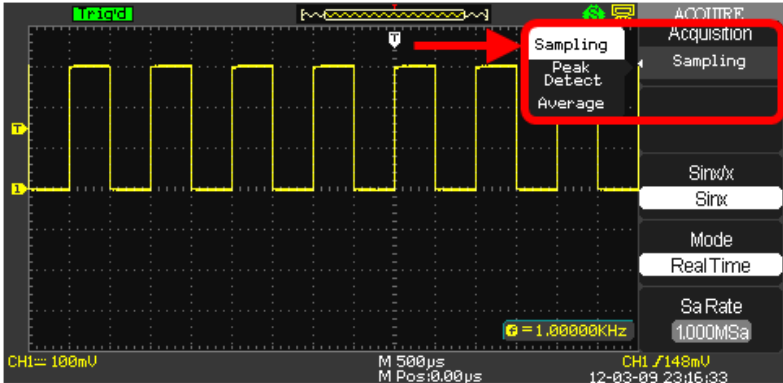

3. If you select the **Average** sampling type, press the **Averages** option button and select the number of waveforms (4, 16, 32, 64, 128, or 256).

Sinx/x

Choose **Sinx** or **x** by pressing the corresponding option button. This turns Sinx/x on or off, respectively.

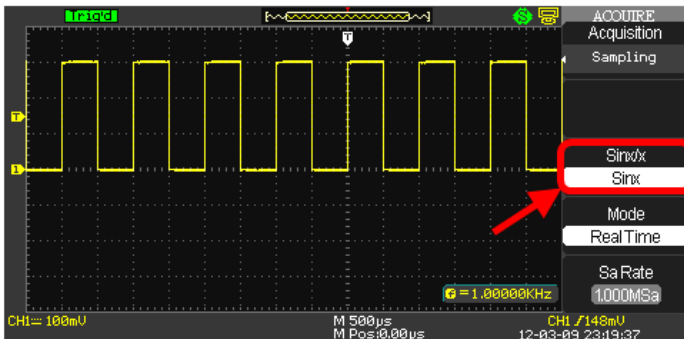

Sinx/x interpolation is suitable for reconstructing curved or irregular wave shapes, especially when the sample rate is 3 to 5 times the system bandwidth.

Mode Selection

You can choose between **Equivalent Time Sampling** and **Real Time Sampling** settings.

- **Equivalent Time Sampling** can achieve up to 20 ps of horizontal resolution (equivalent to 50 GS/s). This mode is good for observing repetitive waveforms.
- **Real Time Sampling** can be used for repetitive and non-repetitive waveforms.

Select from the sampling settings by pressing the **Mode** option button and selecting **Real Time** or **Equ Time**.

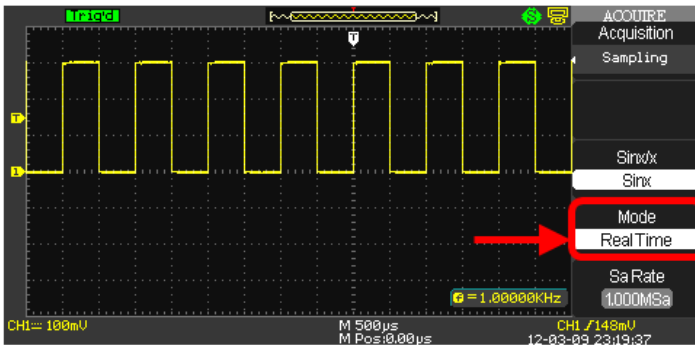

Sampling Rate

Adjust the sampling rate by pressing the **Sa Rate** option button and turning the **Time/div** front panel knob. The sampling rate is shown at the corresponding timebase scale.

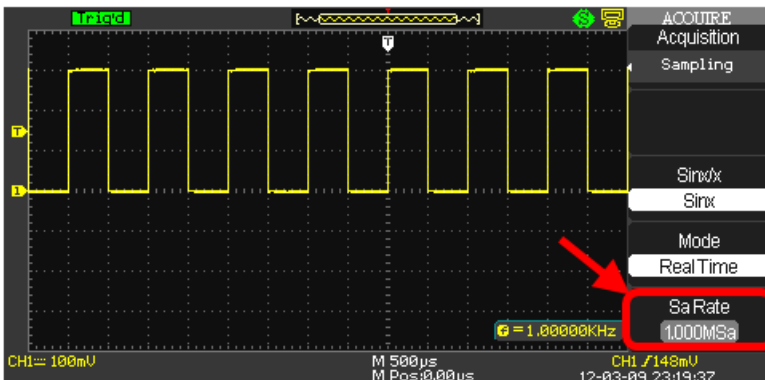

Acquiring Waveforms

You can choose to acquire a single waveform or to acquire waveforms continuously. If you want to acquire a single waveform, press the **SINGLE** front panel button. Each time you press the **SINGLE** front panel button, the oscilloscope begins to acquire another waveform. After the oscilloscope detects a trigger, it completes the acquisition and stops. If you want to acquire waveforms continuously, press the **RUN/STOP** front panel button. Press the button again to stop the acquisition.

When you start an acquisition, the oscilloscope goes through the following steps:

1. Acquires enough data to fill the portion of the waveform record to the left of the trigger point (pre-trigger).
2. Continues to acquire data while waiting for the trigger condition to occur.
3. Detects the trigger condition.
4. Continues to acquire data until the waveform record is full.
5. Displays the waveform.

Changing the Timebase

The oscilloscope digitizes waveforms by acquiring the value of an input signal at discrete points. The timebase allows you to control how often the values are digitized. You can change the timebase using the **Time/div** front panel knob in the **Horizontal Control** group.

NOTE: As you turn the **Time/div** front panel knob, the value is displayed at the lower-center of the display as described in **Understanding Display Information** (on page 19).

Zooming Waveforms

The **Delayed** option button on the **Horizontal** menu (or pressing the **Time/Div Front Panel** (on page 7) knob) toggles between a state where the display provides a split-screen layout where an upper trace shows the actual waveform with a shaded, mask-like portion covering the non-zoomed portion of the waveform; the lower trace displays the actual zoom segment. While in this view, turn the **Push Zoom Front Panel** (on page 7) knob to adjust the zoom portion of the trace.

1. Press the **HORI MENU** front panel button. The **Horizon** menu is shown.

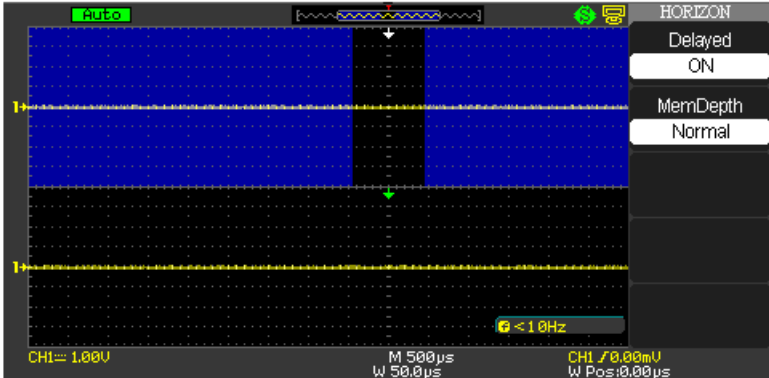

2. Press the **Delayed** option button on the **Horizontal** menu (or pressing the **Time/Div Front Panel** (on page 7) knob).
3. Turn the **Time/Div** front panel knob to adjust the Zoom segment window size.

NOTE: Select a **Delayed ON/OFF** value or press the **Time/Div Front Panel** knob to toggle between a state where the display provides a split-screen layout where an upper trace shows the actual waveform with a shaded, mask-like portion covering the non-zoomed portion of the waveform; the lower trace displays the actual zoom segment. With the Delay value ON or OFF, turning the **Time/Div Front Panel** knob adjusts the Zoom function.

4. Turn the **Horizontal Position Front Panel** (on page 7) knob to adjust the window's position.
5. Press the **MemDepth** option button to select from **Normal** and **LongMem** values.

Triggering

Trigger Types

There are five trigger types: **Edge**, **Video**, **Pulse**, **Slope**, and **Alternative**.

Access the trigger modes by pressing the **TRIG MENU** front panel button (in the Trigger control group) and selecting **Type** from the **Trigger** menu.

Edge Triggering



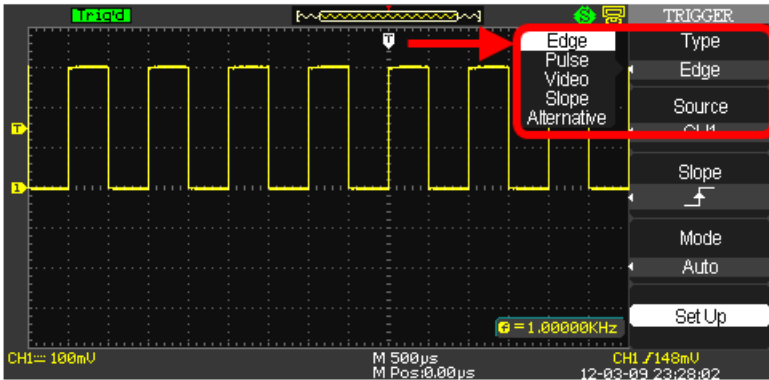



1. Press the **Type** menu option button and select **Edge**.



2. Press the **Source** option button to choose a channel input (**CHS 1 - 2**; or **CHS 1 - 4** on 4 channel models) or **EXT**, **EXT/5**, **AC Line** input.
3. Use **Slope** to select a positive or negative edge for Edge Triggering (rising edge, falling edge, or both).
4. Press the **Mode** option button to select **Auto**, **Normal**, or **Single** mode. Use **Auto** mode to let the acquisition automatically run in the absence of a trigger. Use **Normal** mode when you want to see only valid triggered waveforms (when you use this mode the oscilloscope does not display a waveform until after the first trigger). Use **Single** mode when you want the oscilloscope to acquire a single waveform.
5. Press the **Setup...** option button to display the **Trigger Setup...** menu. You can use the **Trigger Setup...** menu to select a coupling mode and define a **Holdoff** value. **Coupling** modes comprise **DC**, **AC**, **HF Reject**, and **LF Reject**. Turn the **Adjust** front panel knob to set the **Holdoff** value.

Pulse Triggering

Use Pulse width triggering to trigger on aberrant pulses. You can select how to compare the trigger pulse relative to the pulse width as follows:

-  Positive pulse width less than pulse width setting
-  Positive pulse width larger than pulse width setting
-  Positive pulse width equal to pulse width setting
-  Negative pulse width less than pulse width setting
-  Negative pulse width larger than pulse width setting
-  Negative pulse width equal to pulse width setting

To set a pulse trigger:

1. Press the **Type** option button and select **Pulse**.

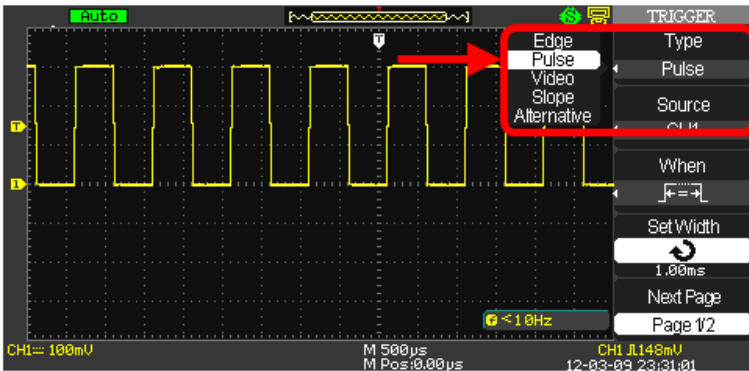

2. Press the **Source** option button to choose a channel input (**CHS 1 - 2**; or **CHS 1 - 4** on 4 channel models) or **EXT**, **EXT/5**, **AC Line** input.
3. Press the **When** option button to select how to compare the trigger pulse relative to the value selected in the Set Width option.
4. Press the **Set Width** option button and then turn the **Adjust** front panel knob to set the pulse width.
5. Press the **Next Page** option button.
6. Press the **Mode** option button to select **Auto**, **Normal**, or **Single** mode. Use **Auto** mode to let the acquisition automatically run in the absence of a trigger. Use **Normal** mode when you want to see only valid

triggered waveforms (when you use this mode the oscilloscope does not display a waveform until after the first trigger). Use **Single** mode when you want the oscilloscope to acquire a single waveform.



- Press the **Setup...** option button to display the **Trigger Setup...** menu. You can use the **Trigger Setup...** menu to select a coupling mode and define a **Holdoff** value. **Coupling** modes comprise **DC**, **AC**, **HF Reject**, and **LF Reject**. Turn the **Adjust** front panel knob to set the **Holdoff** value.

Video Triggering

Use Video Triggering to trigger on fields or lines of standard video signals.

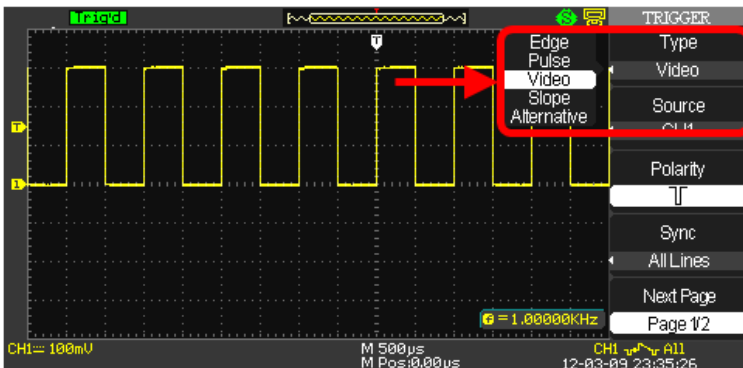
- Press the **Type** option button and select **Video**.



- Press the **Source** option button to choose a channel input (**CHS 1 - 2**; or **CHS 1 - 4** on 4 channel models) or **EXT**, **EXT/5**, **AC Line** input.
- Press the **Polarity** option button and select  (Normal) or  (Inverted). Normal triggers on the negative edge of the sync pulse. Inverted triggers on the positive edge of the sync pulse.
- Press the **Sync** option button and select a video sync (**Line Num**, **All Lines**, **Odd Field**, **Even Field**). If you select **Line Num**, you can turn the **Adjust** front panel knob to set the appointed line number.
- Press the **Next Page** option button.
- Press the **Standard** option button and select the video standard for sync and line number count (**NTSC** or **Pal/Secam**).
- Press the **Mode** option button to select **Auto**, **Normal**, or **Single** mode. Use **Auto** mode to let the acquisition automatically run in the absence

of a trigger. Use **Normal** mode when you want to see only valid triggered waveforms (when you use this mode the oscilloscope does not display a waveform until after the first trigger). Use **Single** mode when you want the oscilloscope to acquire a single waveform.

- Press the **Setup...** option button to display the **Trigger Setup...** menu. You can use the **Trigger Setup...** menu to select a coupling mode and define a **Holdoff** value. **Coupling** modes comprise **DC**, **AC**, **HF Reject**, and **LF Reject**. Turn the **Adjust** front panel knob to set the **Holdoff** value.

Slope Triggering

Use Slope Triggering to trigger on the positive slope or negative slope depending on the trigger conditions and time you set.

- Press the **Type** option button and select **Slope**.

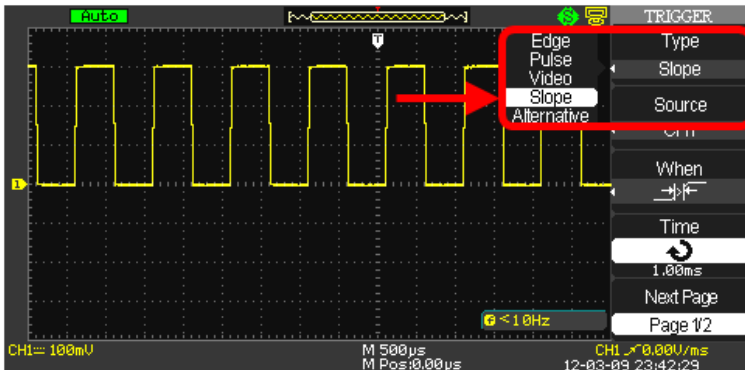

- Press the **Source** option button to choose a channel input (**CHS 1 - 2**; or **CHS 1 - 4** on 4 channel models) or **EXT**, **EXT/5**, **AC Line** input.
- Press the **When** option button to select the trigger condition.
- Press the **Time** option button and then turn the **Adjust** front panel knob to set the slope time.
- Press the **Next Page** option button.
- Press the **Vertical** option button and select the trigger level that can be adjusted using the **Level** front panel knob. You can adjust Level A, Level B, or adjust both at the same time.
- Press the **Mode** option button to select **Auto**, **Normal**, or **Single** mode. Use **Auto** mode to let the acquisition automatically run in the absence of a trigger. Use **Normal** mode when you want to see only valid

triggered waveforms (when you use this mode the oscilloscope does not display a waveform until after the first trigger). Use **Single** mode when you want the oscilloscope to acquire a single waveform.

- Press the **Setup...** option button to display the **Trigger Setup...** menu. You can use the **Trigger Setup...** menu to select a coupling mode and define a **Holdoff** value. **Coupling** modes comprise **DC**, **AC**, **HF Reject**, and **LF Reject**. Turn the **Adjust** front panel knob to set the **Holdoff** value.

Alternative Triggering

The trigger signal comes from two vertical channels when you use Alternative Triggering. Using this type of trigger, you can observe two unrelated signals at the same time. For each signal, you can select different trigger types, such as Edge, Pulse, Slope, or Video. Trigger information for the two channels is displayed at the bottom right side of the display.

- Press the **Type** option button and select **Alternative**.

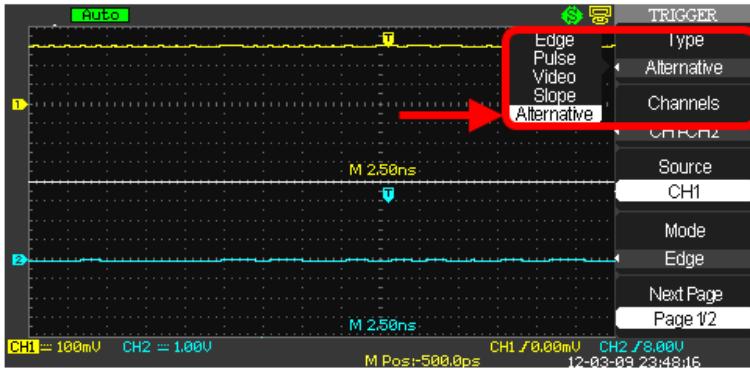

- Set up both triggers by pressing the **Source** option button and selecting a **Source** - CH1 or CH2 (or CH3 or 4 on 4 channel models).
- For the selected Source, press the **Mode** option button and select a Trigger Type (**Edge**, **Pulse**, **Slope**, or **Video**).
- For the selected trigger type, set the trigger options.
- Press the **Setup...** option button to display the **Trigger Setup...** menu. You can use the **Trigger Setup...** menu to select a coupling mode and define a **Holdoff** value. Coupling modes comprise **DC**, **AC**, **HF Reject**, and **LF Reject**. Turn the **Adjust** front panel knob to set the **Holdoff** value.

Analyzing Waveforms

Four main front panel buttons are used for waveform analysis.

- Two **Menu Function** front panel buttons - **Cursors, Measure**
- The other two are **Vertical** front panel buttons - **Math, REF**

The following topics explain their detailed use.

Measuring with Cursors

Cursors are important tools that aid you in measuring signal values. Cursors are boundary markers you can move across the grid. Use cursors to make fast, accurate measurements and eliminate guesswork.

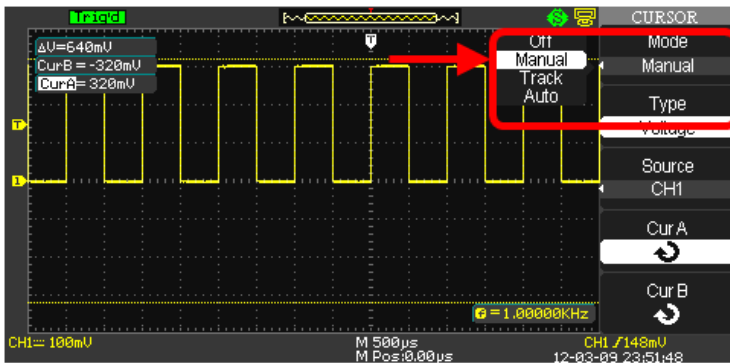

There are three cursor measurement modes:

1. **Manual** - displays two horizontal parallel cursors or vertical parallel cursors to measure voltage or time, respectively.

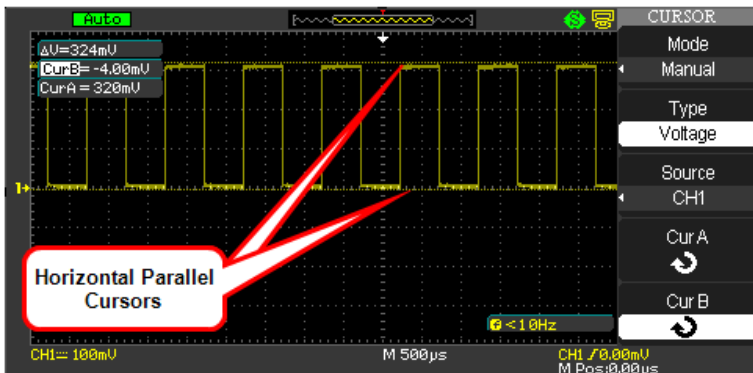

Voltage cursors appear as horizontal lines on the display and measure the vertical parameters. Time cursors appear as vertical lines on the display and measure the horizontal parameters.

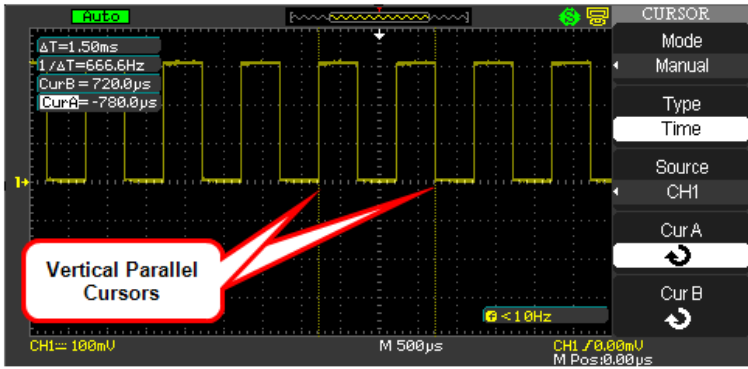

Move cursors by pressing corresponding **CurA**, **CurB** option buttons, and then using the **Adjust** front panel knob. Before using cursors, you should make sure that you have set the signal source as the channel for measuring.

2. **Error! Bookmark not defined.Track** - displays two cross-cursors. The cross-cursors set the position on the waveform automatically.

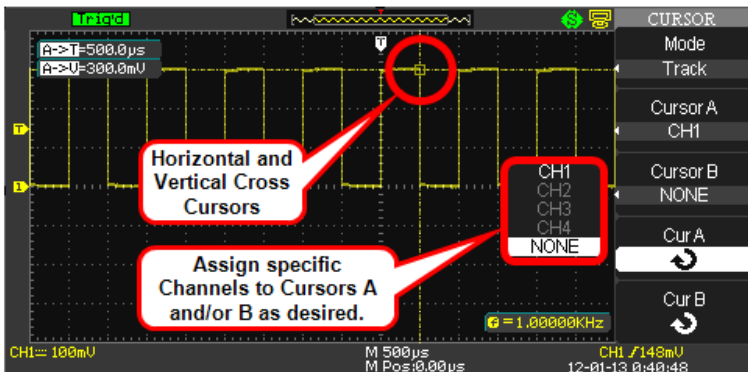

Adjust the cursor position on the waveform by turning the **Adjust** front panel knob. Measurements are shown in the upper-left of the grid.

3. **Auto** - Automatically places markers of what is being measured on the waveform. These markers clarify parameter measurements by displaying cursors and a visual representation of what is being measured. When in Auto cursor mode, as you select measurement parameters the markers will be displayed for the measurements.

Cursor Measurement Selections

- Time cursors are vertical lines that you move horizontally to measure the difference in time or frequency values between the cursors.
- Voltage cursors appear as horizontal lines on the display and measure the vertical parameters.
- Measurement values are shown in the upper-left corner of the grid display and are explained as follows:

Shown in Manual Cursor Mode

▲V - the vertical space between Cursor A and Cursor B (Voltage value between the two cursors)

CurB - the horizontal position of Cursor B (in Volts)

CurA - the horizontal position of Cursor A (in Volts)

Shown in Track Cursor Mode

A→T - the horizontal position of Cursor A (Time cursor centered around the midpoint of the screen)

A→V - the vertical position of Cursor A (Voltage cursor centered on the channel ground level)

B→T - the horizontal position of Cursor B (Time cursor centered on the midpoint of the screen)

B→V - the vertical position of Cursor B (Voltage cursor centered around the channel ground level)

▲T - Horizontal space between Cursor A and Cursor B (Time value between the two cursors)

1/▲T - the reciprocal of the horizontal space between Cursor A and Cursor B

▲V - the vertical space between Cursor A and Cursor B (Voltage value between the two cursors)

Cursor Placement

1. Press the **CURSORS** front panel button. The **Cursor** menu opens.

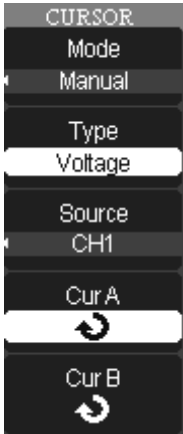

2. Cursors are placed according to the cursor measurement Mode - **Manual**, **Track**, or **Auto** – chosen in one of the following manners:

Manual. Set the mode to Manual by pressing the **Mode** option button until **Manual** is selected. Press the **Type** option button and select **Voltage** (horizontal cursors) or **Time** (vertical cursors). Press the **Source** option button and select a source of **CH1**, **CH2** (also, **CH3** and **4** on 4 channel models). Manual Mode also allows you to choose **MATH**, **REFA**, or **REFB** as a Cursor source. Press the **CurA** or **CurB** option button and turn the **Adjust** front panel knob to adjust the cursors.

Track. Set the mode to Track by pressing the **Mode** option button until **Track** is selected. Press the **Cursor A** or **Cursor B** option button and select a source of **CH1**, **CH2** (also, **CH3** and **4** on 4 channel models) or **NONE**. Press the **CurA** or **CurB** option button and turn the **Adjust** front panel knob to adjust the cursors. If Track is selected, both cursors move in unison and appear slightly brighter on the grid display.

Auto. Set the mode to Auto by pressing the **Mode** option button until **Auto** is selected. When you select measurement parameters using the **MEASURE** front panel button, the cursors are automatically displayed.

NOTE: When using Cursors, their measurement values are always shown in the upper-left corner of the grid display. The cursor selected for placement is indicated by a highlighted icon on the menu and the cursor itself has a higher brightness on the grid display.

Parameter Measurements

Waveform analysis typically begins with the measurement of parameters. Parameter measurement tools determine a wide range of waveform properties. Use them to automatically calculate many of your waveform attributes, like rise time, rms voltage, and peak-to-peak voltage, for example.



Access parameter measurements by pressing the **MEASURE** front panel button. The main Measure menu is shown. Notice how each row on the Measure menu is labeled with a **CHX**, a **Type**, and a **Value**. Each row is a customizable parameter measurement preset.







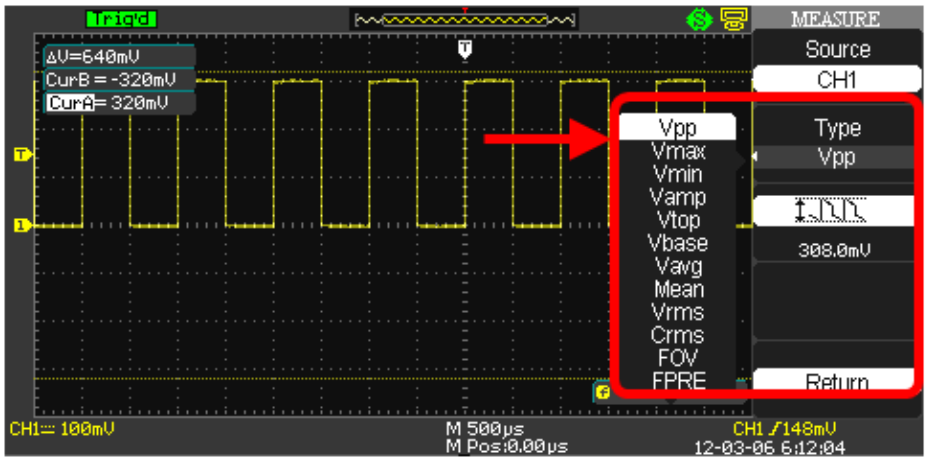

Press the corresponding option button to show additional preset controls for **Voltage**, **Time**, **Delay**, and **AllMea** for the Source channel selected.

Voltage Measurement Parameters



First select a **Source Channel** for your **Voltage** measurement parameter by pressing the Source option button. Now, use the **Type** option button to choose from the following Voltage measurement parameters for your selected source.

- **Vpp** - Difference between highest and lowest points in the waveform.
- **Vmax** - Measures highest point in waveform. Unlike top, it does not assume the waveform has two levels.
- **Vmin** - Measures the lowest point in a waveform. Unlike base, it does not assume the waveform has two levels.
- **Mean** - Average of the data for a time domain waveform. Computed as centroid of distribution for a histogram.
- **Vrms** - Root Mean Square of data between the cursors - about the same as sdev for a zero-mean waveform.
- **Crms** - Cyclic root mean square: Computes the square root of the sum of squares of data values divided by number of points. Contrary to rms, calculation is performed over an integer number of cycles, eliminating bias caused by fractional intervals.
- **Vtop** - Higher of two most probable states, the lower being base; it is characteristic of rectangular waveforms and represents the higher most probable state determined from the statistical distribution of data point values in the waveform.

- **Vbase**  - Lower of two most probable states (higher is top). Measures lower level in two-level signals. Differs from min in that noise, overshoot, undershoot, and ringing do not affect measurement.
- **Vavg**  - Arithmetic mean over the first cycle in the waveform.
- **Vamp**  - Voltage between Vtop and Vbase of a waveform.
- **ROVShoot**  - $(V_{max}-V_{top})/V_{amp}$ after the waveform rising transition.
- **FOVShoot**  - $(V_{min}-V_{base})/V_{amp}$ after the waveform falling transition.
- **RPREShoot**  - $(V_{min}-V_{base})/V_{amp}$ before the waveform rising transition.
- **FPREShoot**  - $(V_{max}-V_{top})/V_{amp}$ before the waveform falling transition.

Time Measurement Parameters

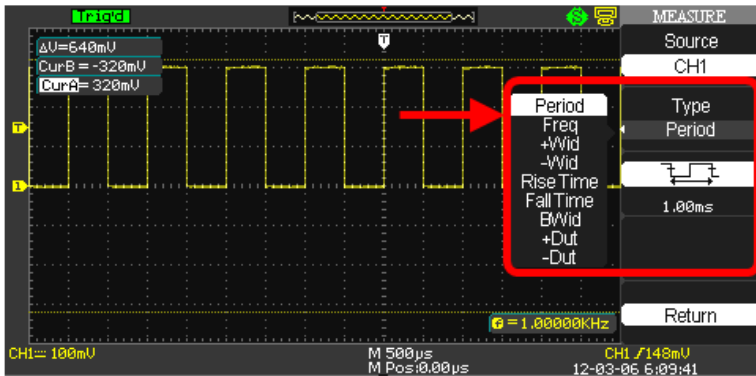







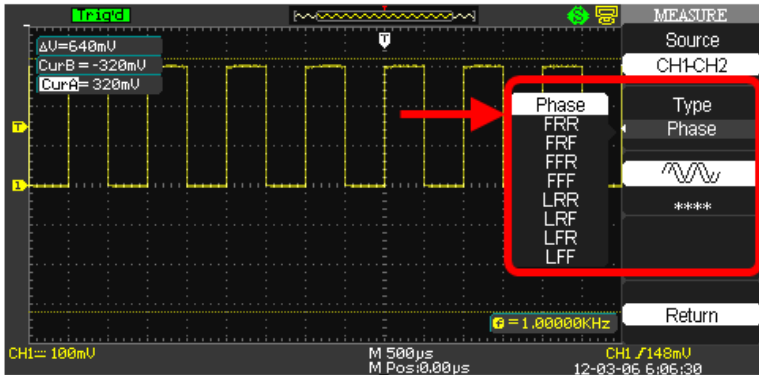

First select a **Source Channel** for your **Time** measurement parameter by pressing the Source option button. Now, use the **Type** option button to choose from the following Time measurement parameters for your selected source.

- **Period** - Period of a cyclic signal measured as time between every other pair of 50% crossings. Starting with first transition after left cursor, period is measured for each transition pair, with values averaged to give final result.
- **+Wid** - Time between the first rising edge and the next rising edge at the waveform 50% level.
- **-Wid** - Time between the first falling edge and the next rising edge at the waveform 50% level.
- **Rise Time** - Duration of pulse waveform's rising transition from 10% to 90%, averaged for all rising transitions between the cursors.
- **Fall Time** - Duration of pulse waveform's falling transition from 90% to 10%, averaged for all falling transitions between the cursors.
- **BWid** - Duration of a burst measured over the entire waveform.
- **+Dut** - Ratio between positive pulse width and period.
- **-Dut** - Ratio between negative pulse width and period.

Delay Measurement Parameters



First select a **Source Channel** for your **Delay** measurement parameter by pressing the Source option button. Now, use the **Type** option button to choose from the following Delay measurement parameters for your selected source.

- **Phase**  - Amount one waveform leads or lags another in time expressed in degrees, where 360 degrees is one waveform cycle.
- **FRR**  - Time between the first rising edge of Source 1 and the first rising edge of Source 2.
- **FRF**  - Time between the first rising edge of Source 1 and the first falling edge of Source 2.
- **FFR**  - Time between the first falling edge of Source 1 and the first rising edge of Source 2.
- **FFF**  - Time between the first falling edge of Source 1 and the first falling edge of Source 2.
- **LRR**  - Time between the first rising edge of Source 1 and the last rising edge of Source 2.
- **LRF**  - Time between the first rising edge of Source 1 and the last falling edge of Source 2.
- **LFR**  - Time between the first falling edge of Source 1 and the last rising edge of Source 2.
- **LFF**  - Time between the first falling edge of Source 1 and the last falling edge of Source 2.

All Mea (surement) Settings

Pressing the **All Mea** option button shows a menu where you can choose to display a given set of measurement values for a **Source Channel**, and turn On or Off its corresponding measurement values for **Voltage** and **Time** on the grid display.

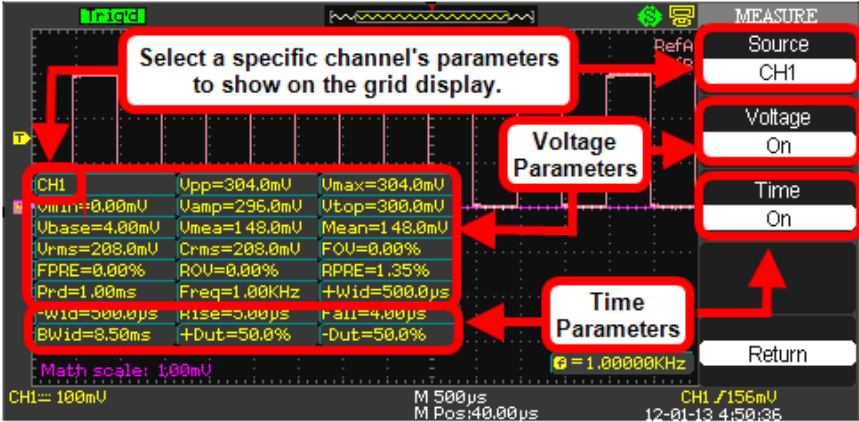

Press corresponding option buttons and make selections as desired.

Waveform Math

Standard math functions include addition, subtraction, multiplication, division, and FFT. For more information on FFT, see the **FFT Spectrum Analyzer** (on page 51) section. Press the **MATH** front panel button in the **Vertical Control** group to display the **Math** menu.

Math on 2 Channel WaveAce Models

1. Press the **Operation** option button and select a math operator **+**, **-**, *****, **/**, or **FFT Spectrum Analyzer** (on page 51).

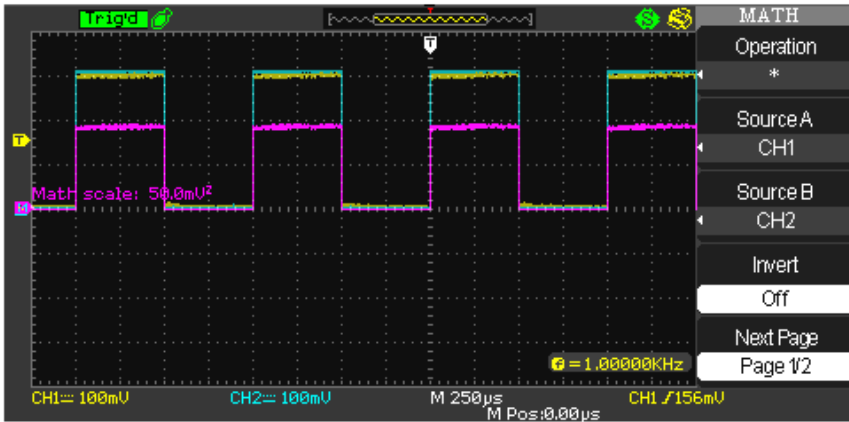

2. The **Source** can be any channel, but not another math trace. Channel behavior for the math operators allow for **CH1-CH2** or **CH2-CH1** selections.

Math on 4 Channel WaveAce Models

Math Menu Pages 1/2 and 2/2 and their options are described as follows:

1. Press the **Operation** option button and select a math operator **A + B, A - B, A * B, /**, or **FFT Spectrum Analyzer** (on page 51).

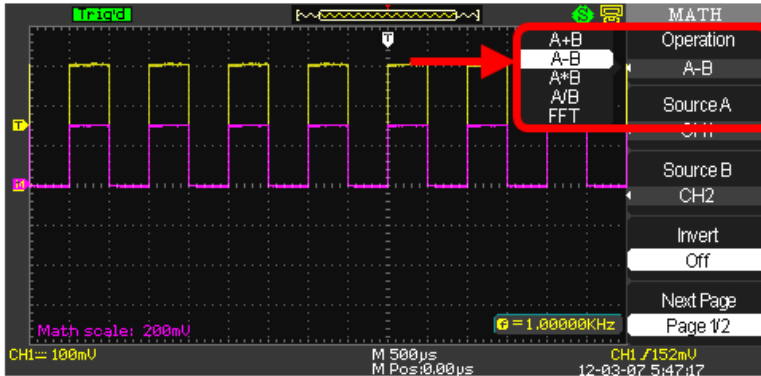

2. The **Source** can be any channel, but not another math trace. Channel behavior for the math operators force **CH1+CH2** or **CH3+CH4** selection pairings (using addition as an example).

NOTE: Invert a waveform by pressing the CH1Invert or CH2Invert (or CH3Invert or CH4Invert on 4 Channel models) option button and select On.

3. **Position your math trace vertically** by pressing the following option button and turning the **Adjust** knob as desired.

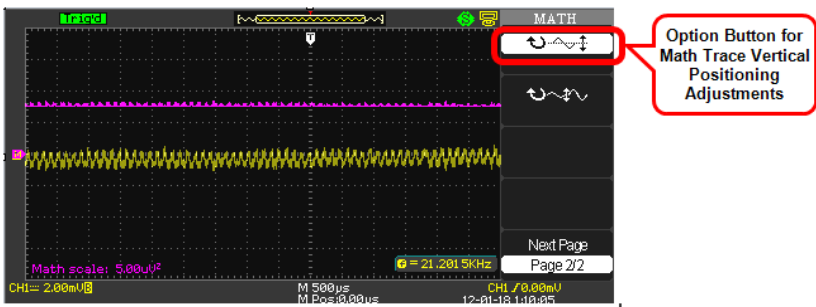

- Adjust the **scale of your math trace** by pressing the following option button and turning the **Adjust** knob as desired.

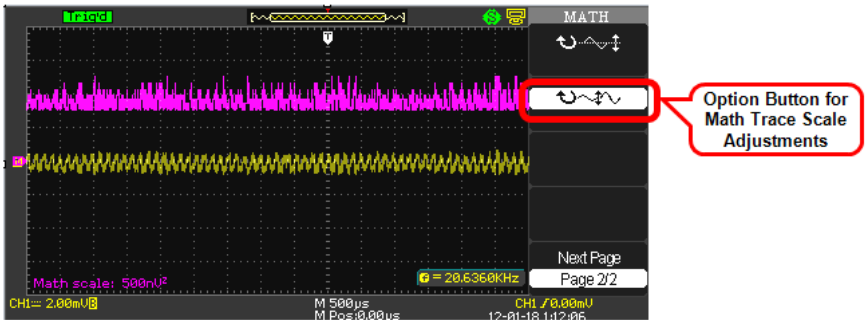

FFT Spectrum Analyzer

The FFT process mathematically converts a time-domain signal into its frequency components. You can display only one FFT waveform at a time. With the FFT Operation selected, the following menu options are shown.

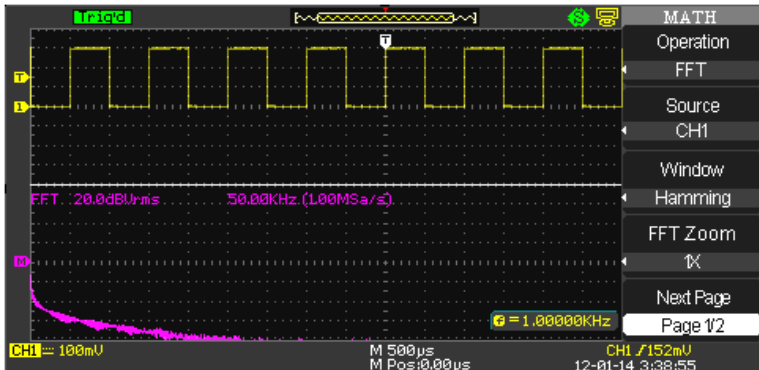

- Press the **Window** option button and select from the following choices.

Window	Description	Test Content
Rectangular	Best frequency resolution, worst magnitude resolution. This is essentially the same as no window.	Symmetric transients or bursts. Equal-amplitude sine waves with fixed frequencies. Broadband random noise with a relatively slowly varying spectrum.
Hanning	Better frequency, worse magnitude accuracy than Rectangular.	Sine, periodic, and narrow-band random noise. Asymmetric transients or bursts.
Hamming	Better frequency, worse magnitude accuracy than Rectangular. Hamming has slightly better frequency	Sine, periodic, and narrow-band random noise. Asymmetric transients or bursts.

Window	Description	Test Content
	resolution than Hanning.	
Blackman	Best magnitude, worst frequency resolution.	Single frequency waveforms to find higher order harmonics.

2. Press the **FFT Zoom** option button and select from **1X**, **2X**, **5X**, and **10X** choices.
3. Use the **Scale** option button to choose either **dBVrms** or **Vrms** appropriately for your FFT trace.

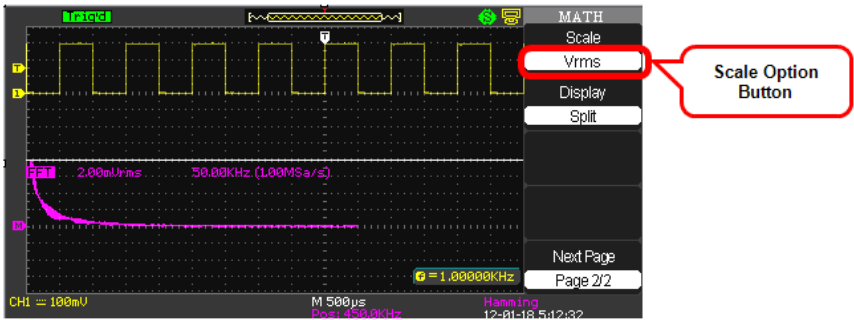

NOTE: The screen-shot above shows a math trace in **Split Display** view.

4. The **Display** option button allows you to choose either **Split** or **Full Screen** for your FFT trace display.

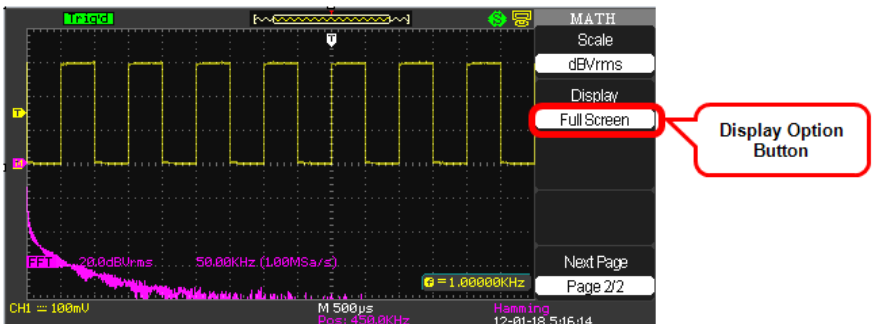

NOTE: The previous screen-shot shows a math trace in **Full Screen** Display view.

Creating Reference Waveforms

Two reference waveforms (REFA and REFB) can be created and saved into internal memory on the oscilloscope.

Reference waveforms can be saved and recalled from volatile memory for quick comparative analysis.

NOTE:

- When reference waveforms are recalled from internal memory, their horizontal position and scale cannot be adjusted.
- However, the oscilloscope does display the horizontal and vertical scales of the recalled reference waveforms at the bottom of the display.
- X-Y mode waveforms are not stored as reference waveforms.

1. Press the **REF** front panel button. The **REF WAV** menu opens.

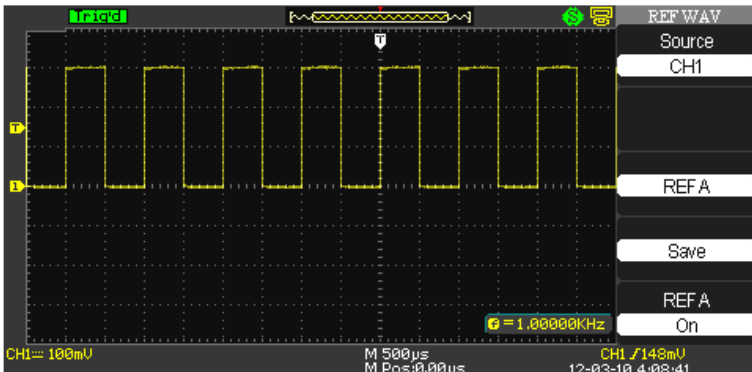

2. Press the **Source** option button to select the input signal channel.
3. Use the lower **REF A** option button to turn the reference waveform **On** or **Off**.

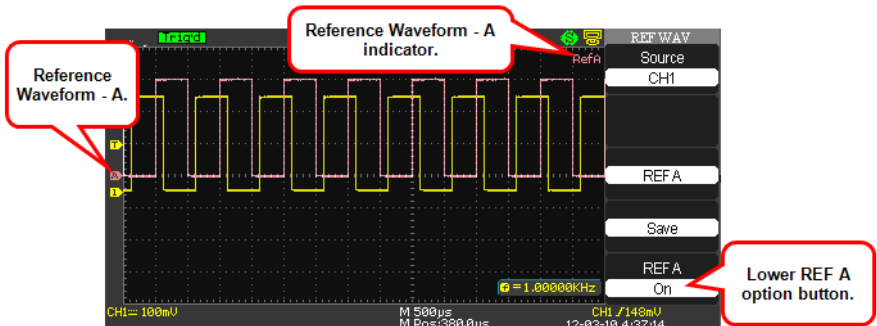

WaveAce 1000/2000

This also shows or hides the reference waveform from the grid display area. Now, you can make adjustments to your waveform leaving the REF A trace intact for comparison. There's also a reference waveform indicator shown on the upper-right of the grid display.

4. Press the middle **REF A** option button to switch from **REF A** to **REF B**. Both the middle and lower REF A option buttons now show labeled as **REF B** and adjustments can be made for the additional reference waveform.

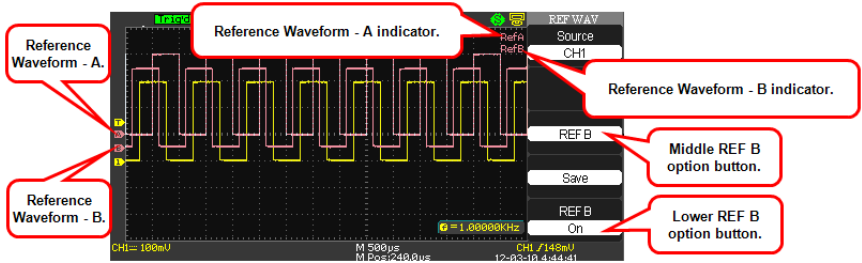

5. Use the **Save** option button to save your reference waveform for comparative analysis at a later time.

NOTE: Keep in mind that the reference waveforms are stored in volatile memory. This means that REF A and REF B are temporarily stored until the next time the oscilloscope is shut down.

Save and Recall

Saving and Recalling Oscilloscope Settings

You can quickly save and recall up to 20 oscilloscope panel settings and 20 waveforms in internal memory. Waveforms and panel settings can also be saved to a USB memory device.

Saving the Current Settings

1. Press the **Save/Recall** front panel button. The **SAVE/REC** menu is shown.
2. Press the **Type** option button and select **Setup**.

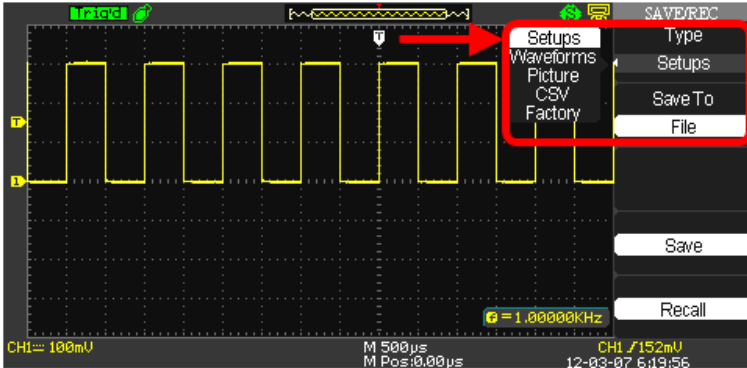

3. Save your setup either to **Device** (meaning internal memory on your WaveAce) or **File** (for storage on a USB memory device) using the following methods.

Saving Setups to Internal Memory

- Press the **Save To** option button to select **Device**.
- Press the **Setup...** option button or turn the **Adjust** front panel knob and assign a number (No. 1 - No. 20) to the setup.
- Press the **Save** option button to save the current setup.
- The setup is saved to memory and the oscilloscope briefly shows a **Store Data Success!** message on the lower part of the grid display area.

Saving Setups to a USB Memory Device

- Insert the USB memory device, press the **Save To** option button and select **File**.
- Press the **Save** option button and the **SAVE ALL** screen opens showing **Directorys** by default. Finish saving your setup using the following instructions in **Using the SAVE ALL Screen** (on page 66).
 - Switch to the [SAVE ALL - Files Menu](#).
 - Name and Confirm your file using the steps explained in [Creating Folders and Files](#).

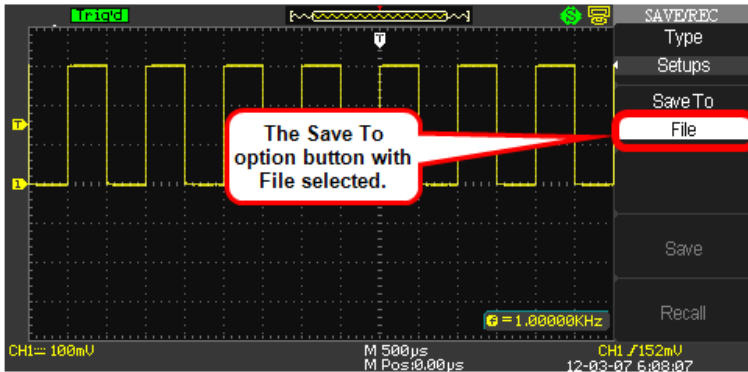

Recalling Setups

1. If you're not already on the **SAVE/REC** menu, press the **Save/Recall** front panel button and the **SAVE/REC** menu is shown.
2. Press the **Type** option button and select **Setups**.
3. Recall your setup either from your **Device** (meaning internal memory on your WaveAce) or from a **File** (stored on a USB memory device) using the following methods.

Recalling Setups from Internal Memory

- Press the **Save To** option button to select **Device**.
- Press the **Setup...** option button or turn the **Adjust** front panel knob to select the number (No. 1 - No. 20) assigned to the setup you want to recall.
- Press the **Recall** option button and the selected Setup is recalled from internal memory. The oscilloscope briefly shows a **Read Data Success!** message on the lower part of the grid display area.

Recalling Setups from a USB Memory Device

- Insert the USB memory device and press the **Save To** option button to select **File**.
- Press the **Recall** option button and the **SAVE ALL** screen is shown. See **Using the SAVE ALL Screen** (on page 67) to continue recalling from your USB memory device.

Saving and Recalling Waveforms

You can quickly save waveforms in internal memory (up to 20 waveforms) or on a USB memory device (limited only by your USB memory device capacity). You can display up to three waveforms at the same time. You can easily recall these saved waveforms later.

Saving Waveforms

1. Display the waveform(s) you want to save and press the **Save/Recall** front panel button. The **SAVE/REC** menu is shown.

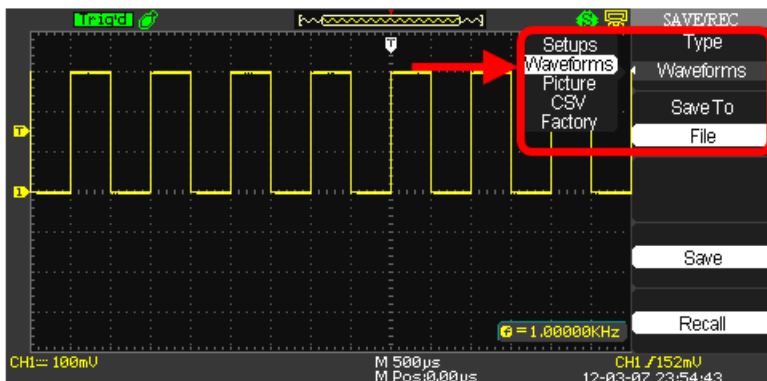

2. Press the **Type** option button and select **Waveforms**.
3. Save the waveform either to **Device** (meaning internal memory on your WaveAce) or **File** (for storage on a USB memory device) using the following methods.

Saving Waveforms to Internal Memory

- Press the **Save To** option button to select **Device**.
- Press the **Waveform** option button or turn the **Adjust** knob to assign a number (No. 1 - No. 20) to the waveform.
- Press the **Save** option button to save the waveform.
- The waveform is saved to memory and the oscilloscope briefly shows a **Store Data Success!** message on the lower part of the grid display area.

Saving Waveforms to a USB Memory Device

- Insert the USB memory device, press the **Save To** option button, and select **File**.

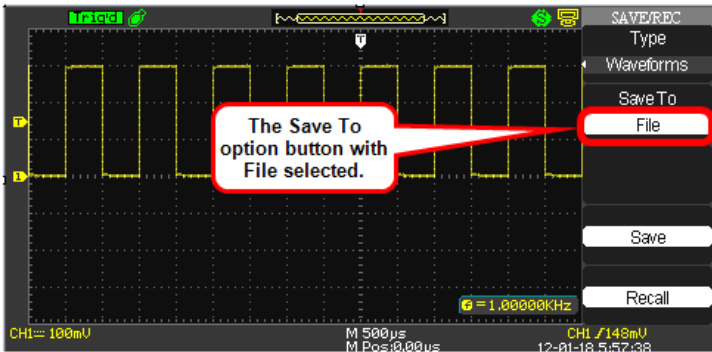

- Press the **Save** option button to save the waveform.
- Now, the **SAVE ALL** screen opens showing **Directory**s by default. Finish saving to your USB memory device using the following instructions in **Using the SAVE ALL Screen** (on page 66).
 1. Switch to the [SAVE ALL - Files Menu](#) - covered in the **Using the SAVE ALL Screen** (on page 66) topic.
 2. Name and Confirm your file using the steps explained in [Creating Folders and Files](#) - also covered in the **Using the SAVE ALL Screen** (on page 66) topic.

Recalling Waveforms

1. If you're not already on the **SAVE/REC** menu, press the **Save/Recall** front panel button and the **SAVE/REC** menu is shown.
2. Press the **Type** option button and select **Waveforms**.
3. Recall the waveform either from your **Device** (meaning internal memory on your WaveAce) or from a **File** (stored on a USB memory device) using the following methods.

Recalling Waveforms from Internal Memory

- Press the **Save To** option button to select **Device**.
- Press the **Waveform** option button or turn the **Universal** front panel knob to select the number (No. 1 - No. 20) assigned to the waveform you want to recall.

- Press the **Recall** option button and the selected Waveform is recalled from internal memory. The oscilloscope briefly shows a **Read Data Success!** message on the lower part of the grid display area.

Recalling Waveforms from a USB Memory Device

- Insert the USB memory device and press the **Save To** option button to select **File**.
- Press the **Recall** option button and the **SAVE ALL** screen is shown. See **Using the SAVE ALL Screen** (on page 67) to continue recalling from your USB memory device.

Saving and Printing Waveform Pictures

You can save a waveform image (.BMP) file to a USB memory device or print a waveform image directly to a USB-connected printer from your WaveAce.

Once you have set up your print options as explained in **Print Setup** (on page 78) and connected the device to the USB port, you can press the **Print** front panel button to either **Save** or **Print** the image.

Note: Most USB printers supporting **direct printing** through Type A USB port connections are compatible with your WaveAce oscilloscope. Refer to your printer's product documentation to verify compatibility.

1. Press the **Save/Recall** front panel button and the **SAVE/REC** menu is shown.
2. Use the **Type** option button and select **Picture**.

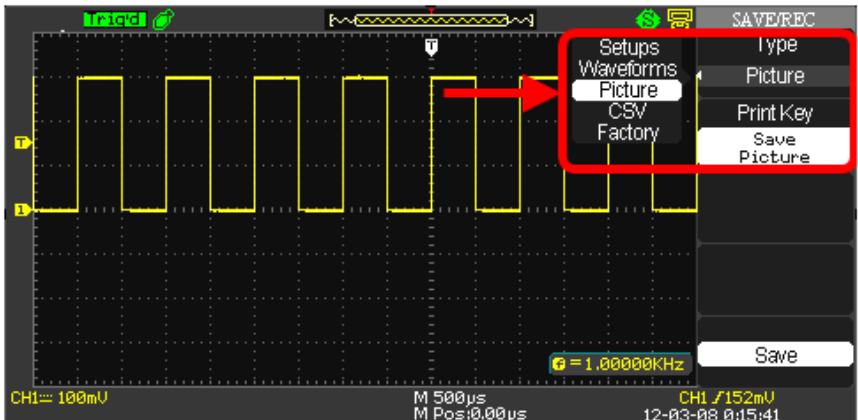

3. Print or Save your .BMP pictures to a USB memory device using the following methods.

Printing Directly to a Printer

- Press the **Print Key** option button and select **Print Picture**. Be sure a printer is connected to your WaveAce oscilloscope.
- Now, press the **Print** option button on your oscilloscope.

Saving .BMP Pictures to a USB Memory Device

- Insert the USB memory device, press the **Print Key** option button and select **Save Picture**.
- Press the **Save** option button and the **SAVE ALL** screen opens showing **Directorys** by default. Finish saving your picture using the following instructions in **Using the SAVE ALL Screen** (on page 66).
 - Switch to the [SAVE ALL - Files Menu](#) - covered in **Using the SAVE ALL Screen** (on page 66).
 - Name and Confirm your file using the steps explained in [Creating Folders and Files](#) - also covered in **Using the SAVE ALL Screen** (on page 66).

NOTE:

- As explained in **Utility Menu** (on page 69), set the **Back USB** option button to **Computer** if you want to save bitmap pictures or **Printer** if you want to print the pictures.
- With either **Save** or **Print Picture** chosen from the **Print Key** option button (and corresponding options setup as explained in **Print Setup** (on page 78)), simply press the **Print** front panel button to instantly execute your selected function.
- The **Recall** option is excluded from Save/Recall menus when **Picture** or **CSV** is selected as the **Type**.
- The **Load** option is disabled (grayed-out) on menus inside the **SAVE ALL** screen when **Pictures** or **CSV** file types are selected as **Type**.

Saving Data as a .CSV File

You can save waveform data as a comma-separated value (.CSV) file. You can then use this information in other applications, such as Microsoft Excel. The .CSV file contains the data points (horizontal and vertical information) of the displayed waveform. You can also choose to save these parameters to the .CSV file:

Record Length	Horizontal Units
Sample Interval	Horizontal Scale
Trigger Point	Model Number
Vertical Units	Serial Number
Vertical Scale	Software Version
Vertical Offset	

1. Press the **Save/Recall** front panel button. The **SAVE/REC** menu opens.

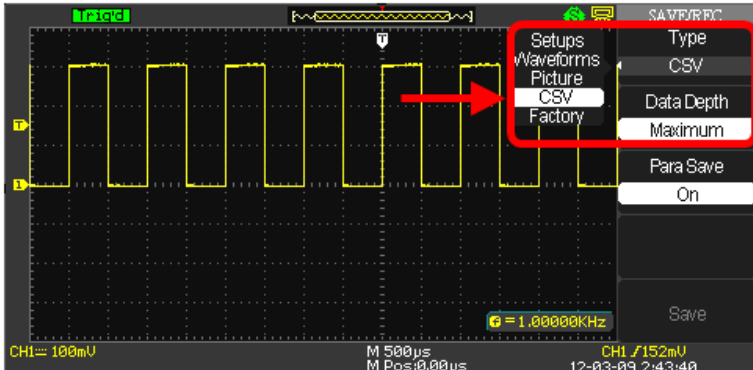

2. Press the **Type** option button and select **CSV**.
3. Press the **Data Depth** option button and select **Maximum** or **Displayed**. These values correspond to **all waveform data for the channel** or **just the exact waveform data shown within the grid display**, respectively.
4. Press the **Para Save** option button and select **On** or **Off**. Turning on Para Save (short for Parameter Save) retains additional data values into your .CSV file.
 - **Values with Para Save turned Off** include **Source** (Channel), **Second** (Time in Seconds), and **Volt** (Amplitude in Volts).
 - **Additional Values with Para Save turned On** include **Record Length**, **Sample Interval**, **Vertical Unit**, **Vertical Scale**, **Vertical Offset**, **Horizontal Units**, **Horizontal Scale**, **Model Number**, **Serial Number**, and **Software Version**.

WaveAce 1000/2000

5. Press the **Save** option button and the **SAVE ALL** screen opens showing **Directorys** by default. Finish saving your .CSV file using the following instructions in **Using the SAVE ALL Screen** (on page 66).
 - Switch to the [SAVE ALL - Files Menu](#).
 - Name and Confirm your file using the steps explained in [Creating Folders and Files](#).

NOTE: The **Recall** option is excluded from Save/Recall menus when **Picture** or **CSV** is selected as the **Type**. The **Load** option is disabled (grayed-out) on menus inside the **SAVE ALL** screen when **Pictures** or **CSV** file types are selected as **Type**.

Recalling Factory Settings

The oscilloscope is set up for normal operation when it is shipped from the factory. Applying the default setup **does not** Language option, saved reference waveform files, saved setup files, display contrast, calibration data.

There are two ways to reload the factory settings:

1. Press the **DEFAULT SETUP** front panel button.

OR

2. Press the **Save/Recall** front panel button. The **SAVE/REC** menu opens. Press the **Type** option button and select **Factory**.

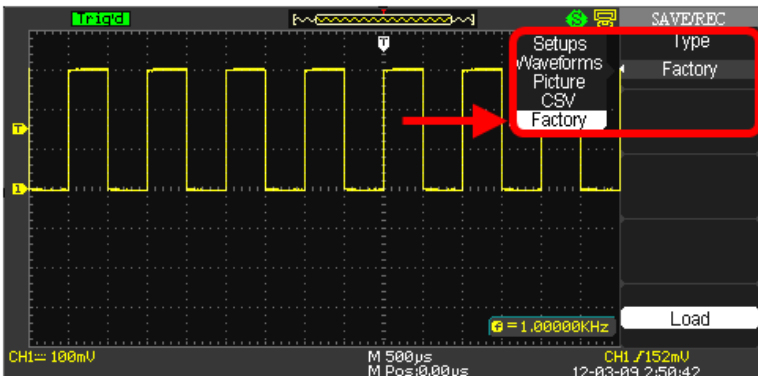

3. Now, press the **Load** option button.

The default settings made to the oscilloscope are detailed as follows:

Menu	Option	Default
CH1,CH2	Coupling	DC

Menu	Option	Default
(2 Channel Models) CH1 - CH4 (4 Channel Models)	BW Limit	Off
	Volts/div adjust	Coarse (fixed)
	Probe	1X
	Invert	Off
	Volts/div	1.00V

Menu	Option	Default	
MATH	Operation (2 Channel Models)	CH1-CH2	
	Operation (4 Channel Models)	CH1-CH2, CH3-CH4	
	CH1 Invert	Off	
	CH2 Invert	Off	
	CH3 Invert (4 Channel Models)	Off	
	CH4 Invert (4 Channel Models)	Off	
	FFT Operation		
	Source	CH1	
	Window	Hanning	
	FFT Zoom	1X	
	Scale	dBVrms	

Menu	Option	Default
HORIZONTAL	Window	Main
	Position	0.00 μ s
	Sec/div	500 μ s
	Window Zone	50.0 μ s
	Trigger Knob	level

WaveAce 1000/2000

Menu	Option	Default
CURSOR	Type	Off
	Source	CH1
	Horizontal (voltage)	± 3.2 divs
	Vertical (time)	± 5 divs

Menu	Option	Default
MEASURE	Source	CH1
	Type	average

Menu	Option	Default
ACQUIRE	Mode	Sampling
	Averages	16

Menu	Option	Default
DISPLAY	Type	Vectors
	Persist	Off
	Grid	
	Menu Display	Infinite

Menu	Option	Default
REF	Type	Waveform
	Source	CH1

Menu	Option	Default
TRIGGER (Edge)	Type	Edge
	Source	CH1
	Slope	Rising
	Mode	Auto
	Coupling	DC
	Level	0.00V

Menu	Option	Default
TRIGGER (Pulse)	Type	Pulse
	Source	CH1
	When	=
	Set Pulse Width	1.00ms
	Mode	Auto
	Coupling	DC

Menu	Option	Default
TRIGGER (Video)	Type	Video
	Source	CH1
	Polarity	Normal
	Sync	All Lines
	Standard	NTSC

Menu	Option	Default
TRIGGER (Slope)	Type	Slope
	Source	CH1
	Mode	Auto

Menu	Option	Default
TRIGGER (Slope)	Type	Alternative
	Source	CH1

Using the SAVE ALL Screen

The SAVE ALL screen is divided into functions (**New**, **Delete**, **Load**, and **Rename**) based on modifying a **Directory** or **Files** when saving items to a USB memory device.

NOTE: The SAVE ALL screen opens showing **Directory** by default. Press the first **Modify** option button to toggle between **Directory** and **Files** menus.

SAVE ALL- Directory Menu

Directory shows option buttons for **New Dir.**, **Del Folder**, and **Load**.

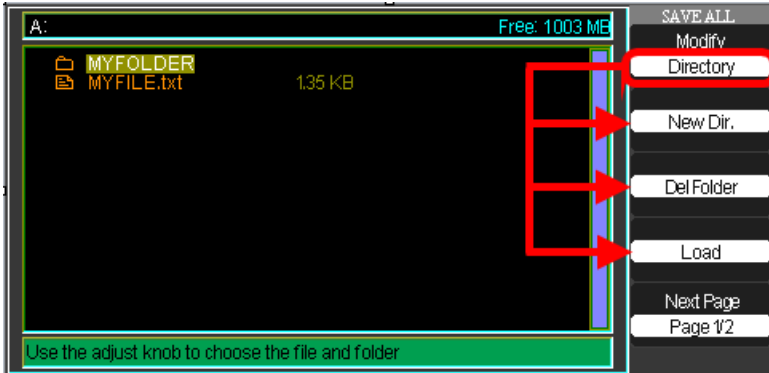

SAVE ALL- Files Menu

Files shows option buttons for **New File**, **Delete File**, and **Load**.

NOTE: Use these **File** functions to save **Setups**, **Waveforms**, **Pictures**, and **Data**.

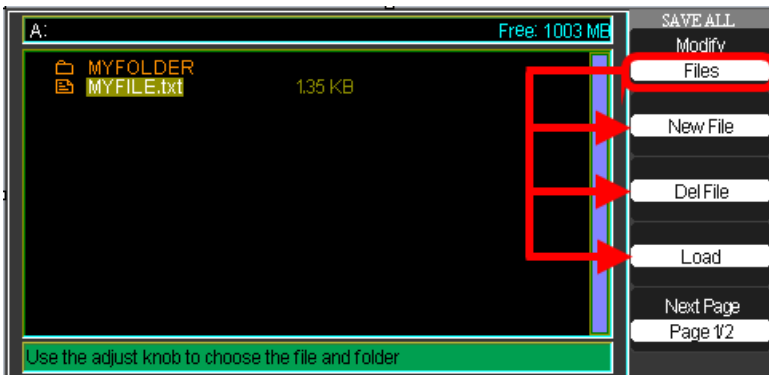

Recalling Files

The **Load** button is used to recall your setup files. Once you've navigated to the desired file and it's highlighted in the main screen area, press the **Load** option button and the setup is recalled from the USB memory device.

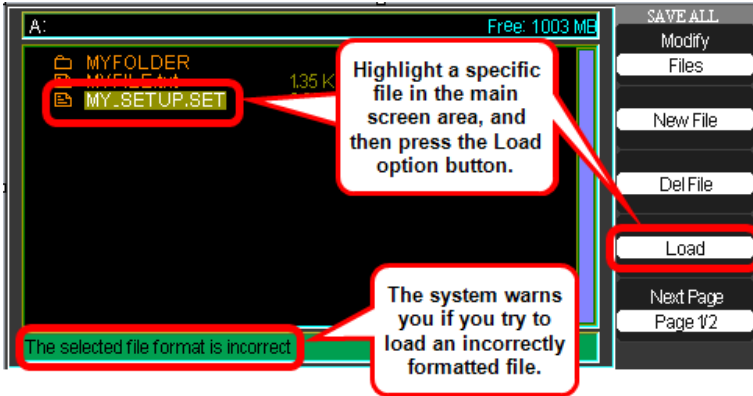

NOTE:

- As shown in the previous screen-shot, the system warns you if you try to load an incorrectly formatted file.
- The **Load** option is disabled (grayed-out) when **Pictures** or **CSV** file types are selected as **Type**.

SAVE ALL Menu - Page 2/2

Both Directories and Files have **Rename** and **Return** option buttons on **Page 2/2**. Use these buttons to give an existing folder or file a new name or to exit the SAVE ALL screen, respectively.



Creating Folders and Files

Create new folders and files by pressing the **New Folder** or **New File** option button. Also, when you select the **Rename** function for a **Folder** or **File**, the following screen is shown.

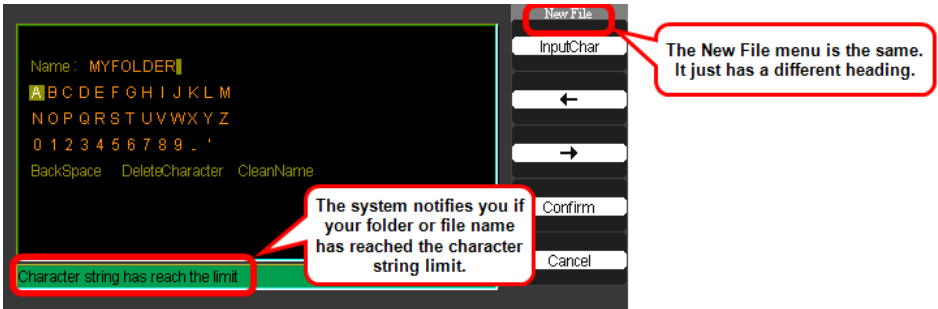

- The **New File** menu choices and behavior is the same as the **New Folder** menu. It just has a different heading. The **InputChar** option button adds the selected character to the cursor position in the **Name** field.
- Move the cursor position in the name field using the **→** and **←** option buttons.
- Turn the **Adjust Front Panel** (on page 7) knob to move through character selections. When the desired character is highlighted, push the **Adjust** knob or press the **InputChar** option button to add it to the specific position in the Name field.
- Additional selections for **BackSpace**, **DeleteCharacter**, and **CleanName** are available for convenience and are also accessed using the **Adjust** knob in the same manner.

Press the **Confirm** option button (when you have the **Name** field completed as desired) to rename or save the folder/file onto the memory device.

After the **Confirm** option button is pressed, a **Data Store Success!** message is briefly shown and the new **Folder** or **File** is saved and shown on your memory device, if applicable.

The system notifies you if your folder or file name has reached the character string limit.

Utilities

Utility Menu

You can use the **Utility** menu to configure your oscilloscope. Press the **UTILITY Front Panel** (on page 7) button to display the **Utility** menu. The first of four available pages containing various utility functions is shown. The screens and functions are covered in the following sections.

Utility Menu - Page 1/4

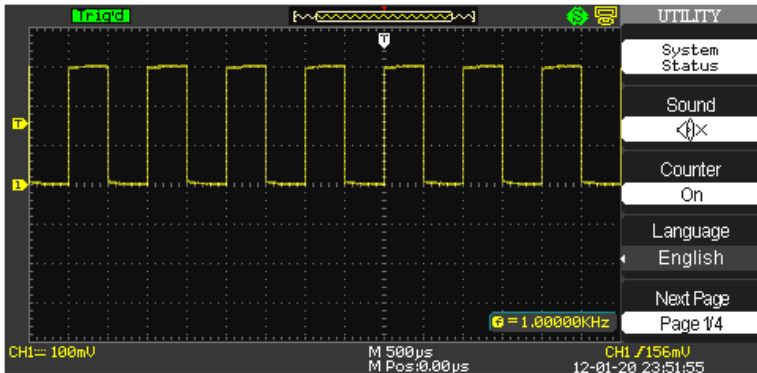

1. Press the **System Status** option button to display a summary of the oscilloscope settings.

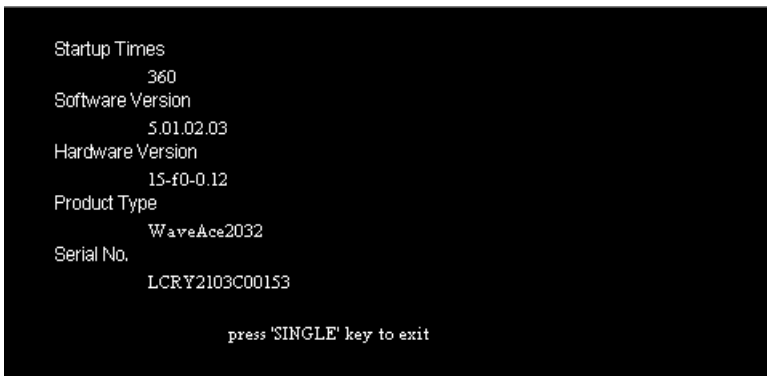

Note: As indicated, press the **SINGLE Front Panel** (on page 7) button to exit the System Status screen.

2. Press the **Sound** option button to turn tones On/Off as desired.

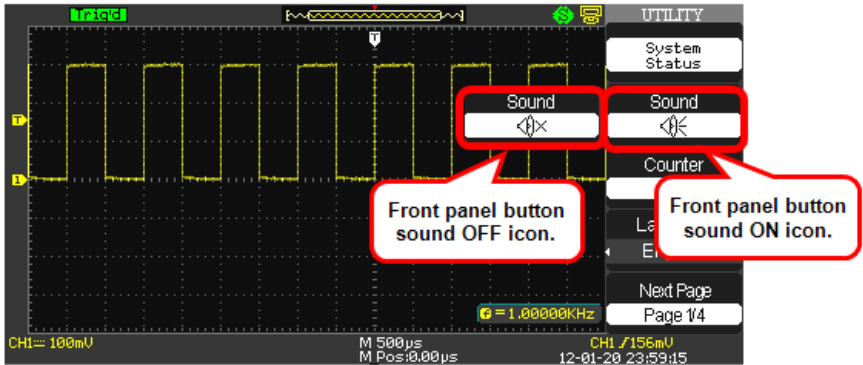

3. Turning the Frequency **Counter** On/Off shows or hides it from the grid display.

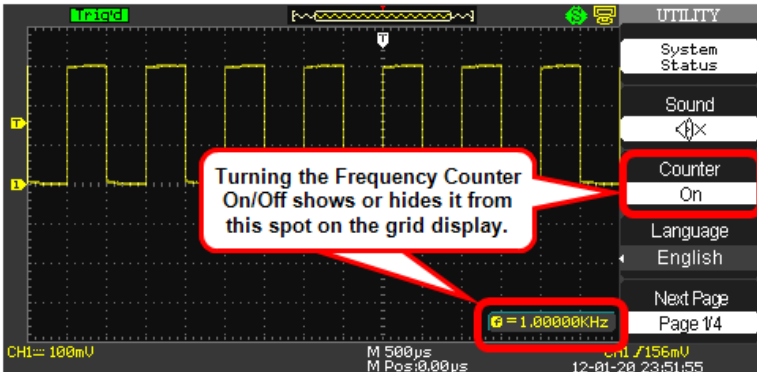

4. Press the **Language** option button to choose the local language of the user interface.
5. Press the **Next Page** option button to display page 2/4.

Utility Menu - Page 2/4

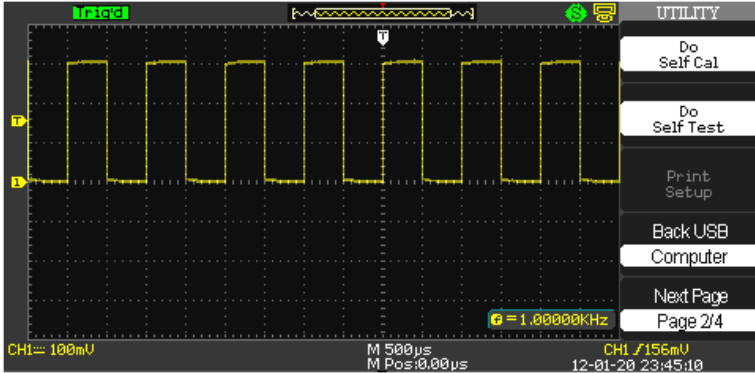
**DO SELF CAL**

1. Press the **Do Self Cal** option button to perform a self-calibration. The **Do Self Cal** screen is shown.

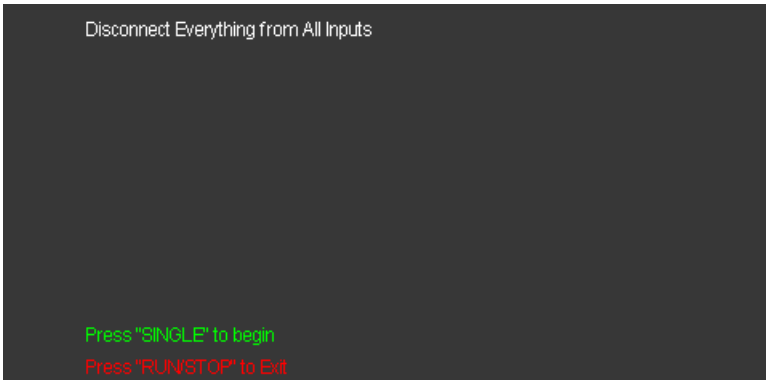

2. As the screen indicates, disconnect anything plugged into input connectors (except for the power cable) before pressing the **SINGLE Front Panel** (on page 7) button and performing a self-calibration. Press the **RUN/STOP** front panel button to exit the **Do Self Cal** screen.
3. After pressing the **SINGLE** front panel button, a status bar shows the self-calibration progress for each channel on the instrument.

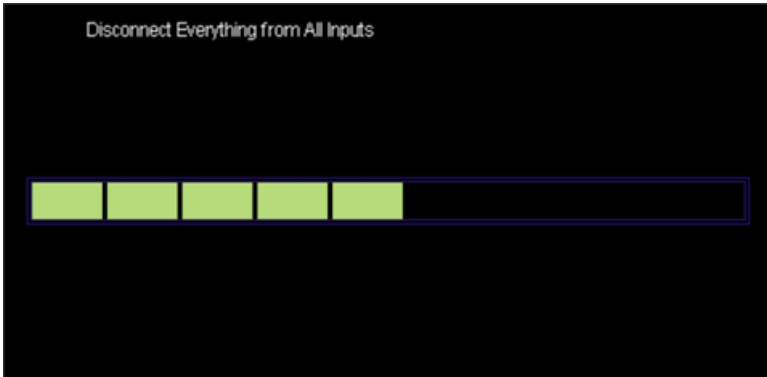

NOTE: The system indicates which channel is being calibrated above the progress bar.

4. Press the **SINGLE** front panel button when self-calibration is complete.



Do SELF TEST

1. Press the **Do Self Test** option button to perform a self-test. A separate **SELF TEST** screen is then shown.

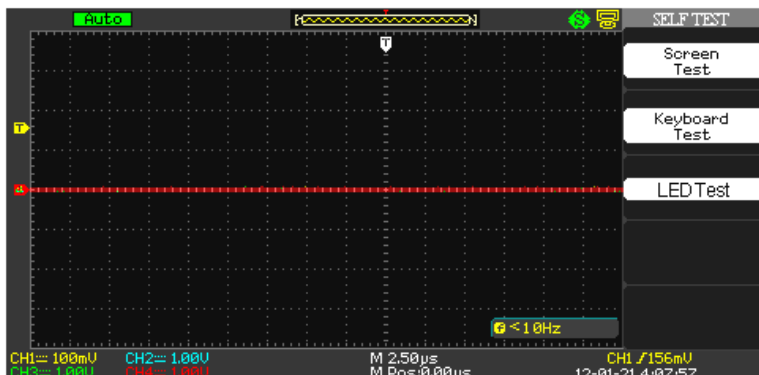

2. Choose from Screen, Keyboard, or LED tests by pressing the respective option button.
3. After making your selection a corresponding screen is shown where either the **SINGLE** or **RUN/STOP** front panel button is used to complete the test and/or exit the test screen, respectively. Screen, Keyboard, and LED Test screens look like the following:

NOTE: After using corresponding option buttons to choose **Do Self Cal**, **Do Self Test**, or **Print Setup** (when enabled by selecting Printer on the Back USB option button), you're taken to a separate menu based on your selection where additional options are then shown. You can always return to the original menu from this menu by pressing the **UTILITY** front panel button.

Press 'SINGLE' key to continue, Press 'RUN/STOP' key to exit

Screen Test - Each press of the SINGLE front panel button runs successively through colors and is how the Screen Test is performed. Move through a few colors until you are satisfied. As the screen indicates, press the RUN/STOP front panel button to exit.

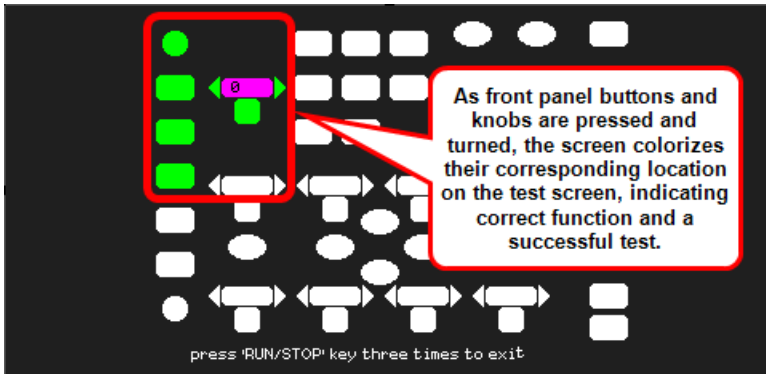

Keyboard Test - As front panel buttons and knobs are pressed and turned, the screen colorizes their corresponding location on the test screen, indicating correct function and a successful test. Test all of the instruments buttons and knobs as desired. As the screen indicates, pressing the RUN/STOP front panel button three times exits the keyboard test.

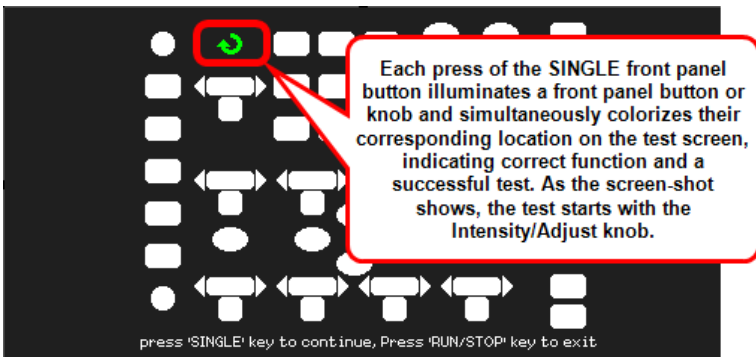

LED Test - Each press of the SINGLE front panel button illuminates a front panel button or knob and simultaneously colorizes their corresponding location on the test screen, indicating correct function and a successful test. As the screen-shot shows, the test starts with the Intensity/Adjust knob. Test as many LEDs as desired. As the screen indicates, press the RUN/STOP front panel button to exit.

PRINT SETUP

1. Press the **Print Setup...** option button to set up your print options. A separate **Print** screen is then shown (Page 1/2).

NOTE:

- Only when the **Back USB** option button (covered in the next step) is set to **Printer** is the **Print Setup...** option button enabled for use.

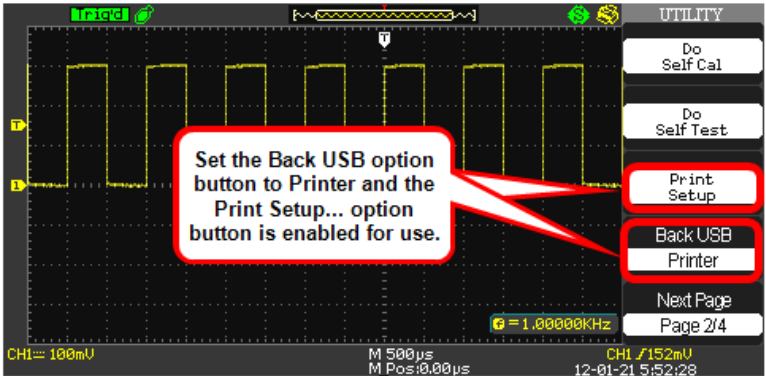

- After using corresponding option buttons to choose **Do Self Cal**, **Do Self Test**, or **Print Setup** (when enabled by selecting **Printer** on the **Back USB** option button), you're taken to a separate menu based on your selection where additional options are then shown. You can always return to the original menu from this menu by pressing the **UTILITY** front panel button.
- When printing, make sure your printer is connected to the back of your WaveAce oscilloscope as covered in **Back and Side Connections** (on page 8).

For more information, see **Print Setup** (on page 78).

BACK USB

Press **Back USB** and choose either **Computer** or **Printer** as desired based on what you connect to your instrument using the USB Type B Receptacle on the back of the oscilloscope as covered in **Back and Side Connections** (on page 8).

Press the **Next Page** option button to display page 3/4.

Utility Menu - Page 3/4

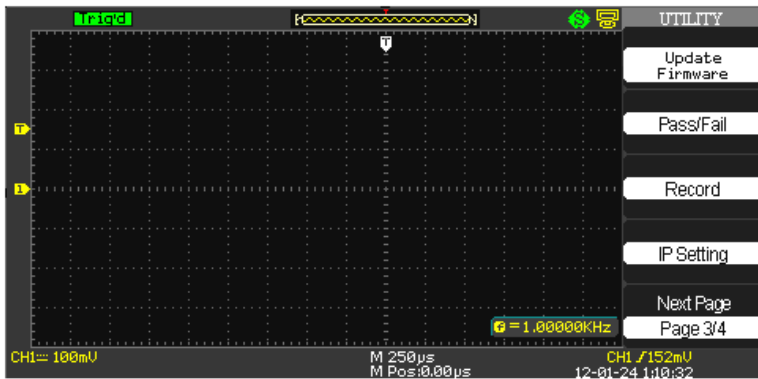

1. Press the **Update Firmware** option button to update the oscilloscope using the USB memory device. For more information, see the **Updating the System Software** (on page 80) section.
2. Pressing the **Pass/Fail** option button shows the **Pass/Fail** menu where you can monitor changes of signals and output pass or fail signals by judging whether the input signal is within the predefined mask. For more information, see **Using Pass/Fail** (on page 82).
3. Pressing the **Record** option button shows the **Record** menu where you can record the input waveform from CH1 and CH2 (also, CH3 and CH4 on four channel versions), with a maximum record length of 2500 frames.

You can record Pass/Fail test output (especially useful when capturing abnormal signals over a long period of time) without having to watch the signal.

Just set the **source**, the **time interval between record frames**, and the **maximum number of record frames**. For more information, see **Using Record** (on page 85).

4. With your oscilloscope connected to your network, pressing the **IP Setting** option button shows Internet Protocol values for your specific **IP Address**, **Subnet Mask**, **Gate Way**, **Port**, **Mac Address**, and **DHCP**.

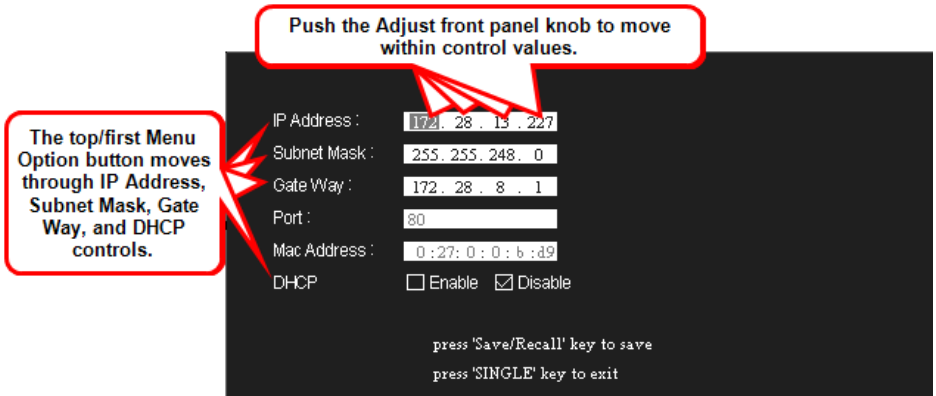

Use the top/first Menu Option button to move through **IP Address**, **Subnet Mask**, **Gate Way**, and **DHCP** controls. Push the **Adjust Front Panel** (on page 7) knob to move within a control and turn the knob to change values.

Note: As indicated, press the **Save/Recall Front Panel** (on page 7) button to save any adjusted values and the **SINGLE** button to exit the **IP Setting** screen.

5. Press the **Next Page** option button on **Utility Menu - Page 3/4** to show page **4/4**.

Utility Menu - Page 4/4

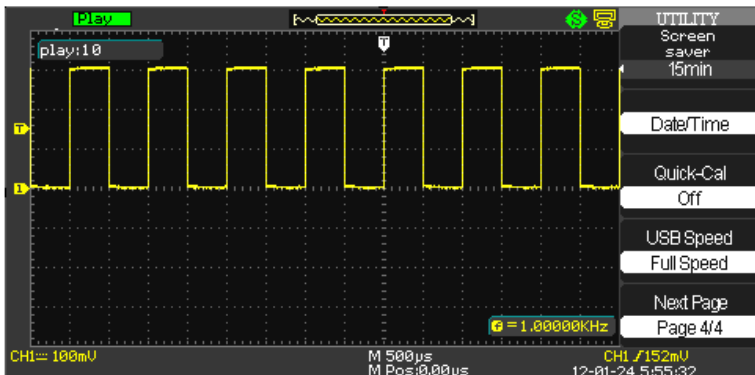

1. Press the **Screen saver** option button to choose from various time lengths before the oscilloscope display goes blank and enters screen saver mode. Time length options include **1min** , **2min**, **5min**, **10min**, **15min**, **30min**, **1hour**, **2hour**, **5hour** and **Off**. Of course, selecting **Off** keeps the oscilloscope from entering screen saver mode entirely.
2. Pressing the **Date/Time** option button shows the **Date/Time** menu where you can make this setting and choose to show it on the lower-right of your display. For more information, see **Setting and Displaying the Date/Time** (on page 89).
3. Press the **Quick-Cal** option button to turn quick calibration **On** or **Off**.
4. Press the **USB Speed** option button to select from **Full** or **High Speed** transfer options for the Back USB connector. See, **Back and Side Connections** (on page 8) for more information.
5. Press the **Next Page** option button to display page 1/4.

Print Setup

NOTE:

- As explained in **Utility Menu** (on page 69), only when the **Back USB** option button is set to **Printer** is the **Print Setup...** option button enabled for use.
- Your printer may override these setup selections to ensure the best fit. If selections are not supported by your printer, the oscilloscope uses the Default setting.
- Most USB printers supporting **direct printing** through Type A USB port connections are compatible with your WaveAce oscilloscope. Refer to your printer's product documentation to verify compatibility.

Print - Page 1/2

After pressing the enabled Print Setup option button, the first of two PRINT menus (Page 1/2) is shown and contains the following option button controls.

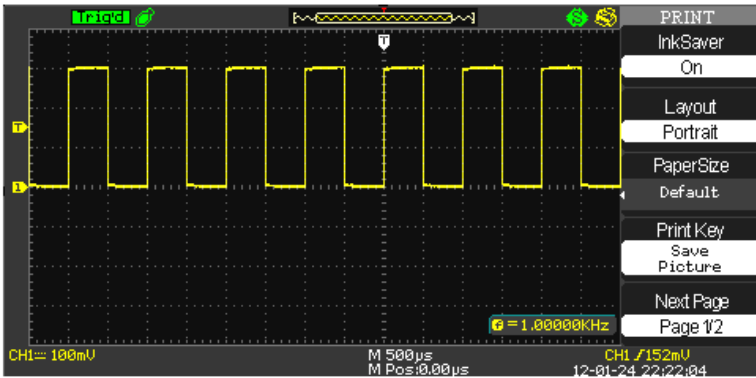

- **Ink Saver** - Turn **On** or **Off** to help save ink when printing.
- **Layout** - Choose from **Portrait** or **Landscape** print layouts as desired.
- **Paper Size** - Choose from **Default**, **L**, **2L**, **Hagaki Postcard**, **Card Size**, **10 x 15cm**, **4" x 6"**, **8" x 10"**, **Letter**, **11" x 17"**, **A0-9**, **B0-9**, **89mm Roll(L)**, **127mm Roll(2L)**, **100mm Roll(4")**, and **210mm Roll(A4)**.
- **Print Key** - Select whether a picture is saved to a USB memory device or printed when the **PRINT** menu control button is pressed.
- **Next Page** - Use this option button to show Page 2/2.

Print - Page 2/2

After pressing **Next Page** from Page 1/2, the second of two PRINT menus (Page 2/2) is shown and contains the following option button controls.

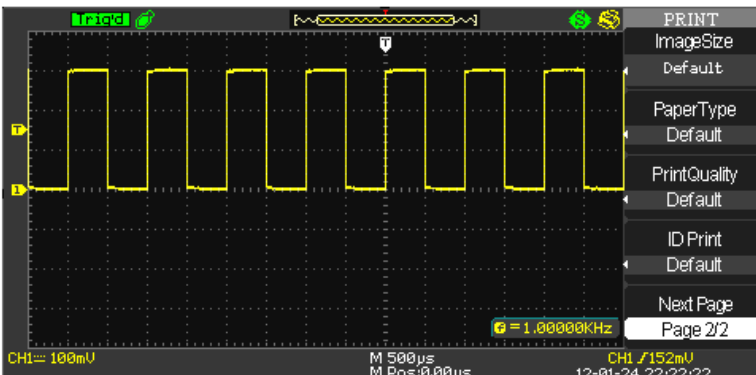

WaveAce 1000/2000

- **Image Size** - Choose from **Default, 2.5x3.25 in, L (3.5x5 in), 4x6 in, 2L (5x7 in), 8x10 in, 4L (7 x 10 in), E, Card, Hagaki card, 6 x 8 cm, 7x10 cm, 9x13 cm, 10x15 cm, 13x18 cm, 15x21 cm, 18x24 cm, and A4, Letter**
- **Paper Type** - Choose from **Default, plain, Photo, and Fast Photo.**
- **Print Quality** - Choose from **Default, Normal, Draft, and Fine.**
- **ID Print** - Choose from **Default, On, and Off.**
- **Next Page** - Use this option button to show Page 1/2.

If desired, press the Utility **Front Panel** (on page 7) button and the **Utility** menu is shown.

Updating the System Software

Teledyne LeCroy periodically releases software updates for the WaveAce providing new features, enhancements, and software corrections. These updates are available for download from the Teledyne LeCroy website at teledynelecroy.com. After registering your product, you can select the appropriate download based on your specific WaveAce oscilloscope model.

	Version	File Size		Compatibility
WaveAce 101 Firmware Upgrade	2.07.02.10	1.07 MB	Download	WaveAce 101
Release Notes WaveAce 101 Firmware Update Procedure WaveAce 101 Firmware Update Procedure - German				
WaveAce 102 Firmware Upgrade	2.07.02.10	1.91 MB	Download	WaveAce 102
Release Notes WaveAce 102 Firmware Update Procedure WaveAce 102 Firmware Update Procedure - German				
WaveAce 112 Firmware Upgrade	2.07.02.10	1.91 MB	Download	WaveAce 112
Release Notes WaveAce 112 Firmware Update Procedure WaveAce 112 Firmware Update Procedure - German				
WaveAce 202 Firmware Upgrade	2.06.02.11	1.91 MB	Download	WaveAce 202
Release Notes				

After downloading, open the .zip file on your computer. The .zip should contain an .ads file and the Firmware Update Procedure .pdf file.

Move the .ads file to a USB memory device.

The system software update .ads file is then loaded through the USB memory port on the front of the oscilloscope.

1. Insert the USB memory device containing the software update in the USB port on the front of the oscilloscope.
2. Press the front panel **Utility** button.
3. Press the **Next Page** menu option button to navigate to menu page **3/4**. Select the **Update Firmware** menu option button. The Update Firmware screen is shown.

NOTE: Verify the firmware product type matches your instrument, and that the firmware update file is stored in the **root directory** of the USB memory device.

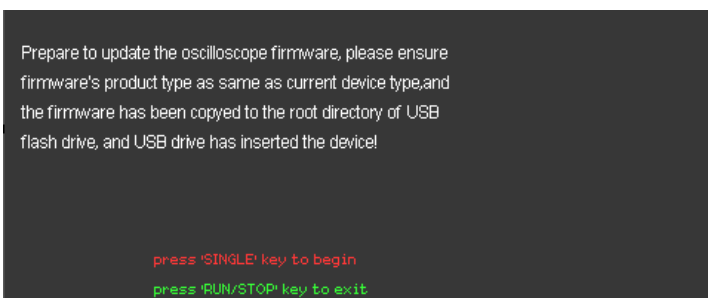

- Press the **SINGLE** front panel button to begin loading the .ads firmware update file from your USB memory device **Using the SAVE ALL Screen** (on page 66). Otherwise, press the **RUN/STOP** front panel button to exit the **Update Firmware** screen.
- Locate the .ads firmware update file, select it, and then press the **Load** option button. The following status screen is shown.

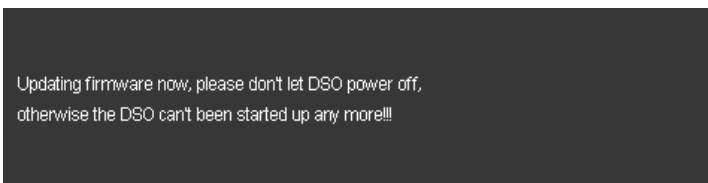

- The oscilloscope then beeps aloud twice and shows a screen stating - **The firmware has been updated completely, please boot up the DSO again.** At this point, turn your oscilloscope power **Off**, wait a short while, and then power it **On** again.

When the oscilloscope has rebooted, your update is complete.

Using Pass/Fail

The Pass/Fail function monitors signal changes determining whether or not it falls within a predefined mask.

Access **Pass/Fail** by pressing the corresponding option button on the **Utility** menu. The first of two Pass/Fail menus is then shown.

Pass/Fail - Page 1/2

After pressing the **Pass/Fail** option button, the first of two Pass/Fail menus (Page 1/2) is shown and contains the following option button controls.

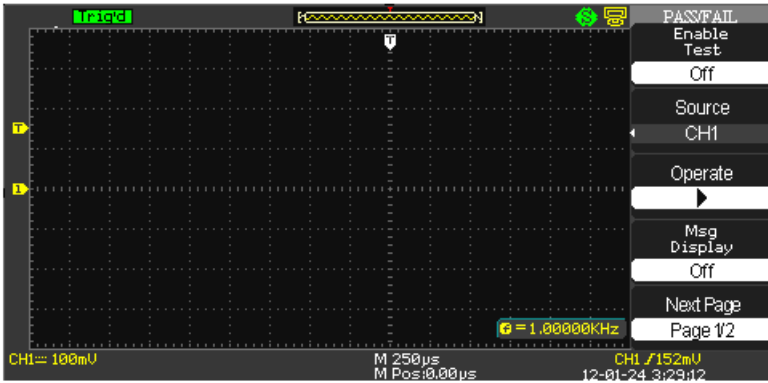

1. Press the **Enable Test** option button to turn the function **On** or **Off**.

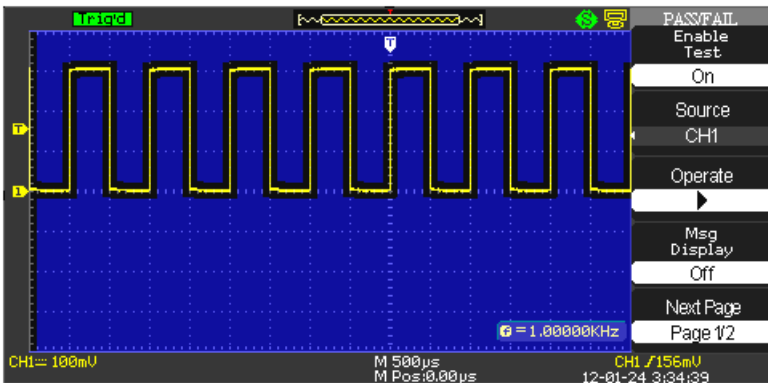

NOTE: Turning **Enable Test On/Off** allows you to control whether or not the mask is shown on the display grid area while making your settings. The **Operate** button runs the test and allows you to see the results update in real time.

2. Press the **Source** option button and select a source (CHS 1 - 2; or CHS 1 - 4 on 4 channel models).
3. Use the **Operate** option button to run and stop the Pass/Fail test.
4. Press the **Msg Display** option button to turn message display **On/Off** during the Pass/Fail test.

Pass/Fail - Page 2/2

After pressing **Next Page** from Page 1/2, the second of two PASS/FAIL menus (Page 2/2) is shown and contains the following option button controls.

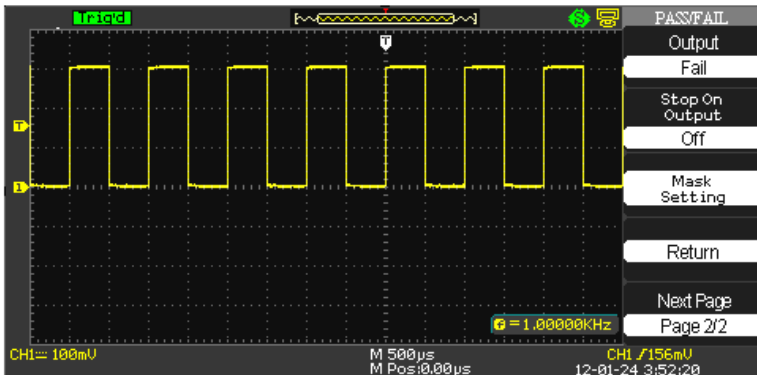

1. Press the **Output** option button to either **Pass** or **Fail**.
2. Press the **Stop On Output** option button and turn it **On/Off** as desired.
3. Use the **Mask Setting** option button to show the **Mask** menu Page 1/2.

Mask - Page 1/2

Mask Page 1/2 contains the following option button controls.

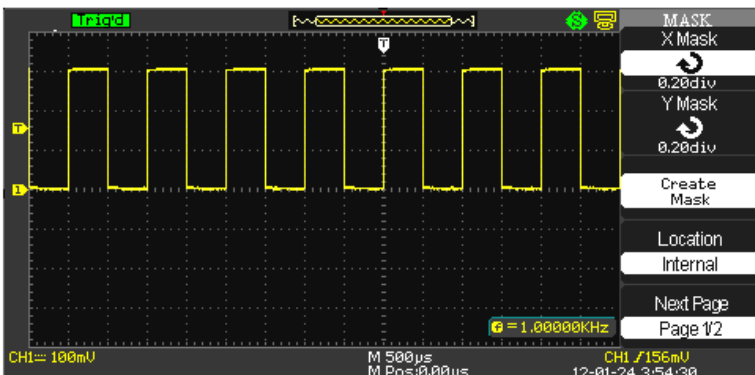

- **X Mask** - Press the **X Mask** option button and use the **Adjust Front Panel** (on page 7) knob to dial in the desired range of horizontal waveform clearance (0.04div - 4.00div).
- **Y Mask** - Press the **Y Mask** option button and use the **Adjust** front panel knob to dial in the desired range of vertical waveform clearance (0.04div - 4.00div).
- **Create Mask** - Press the **Create Mask** option button to create a test mask with the clearances specified using the **X** and **Y Mask** settings.
- **Location** - Press the **Location** option button to select from **Internal** (to store the mask into oscilloscope memory) or **External** (to store the mask onto a USB memory device) **Using the SAVE ALL Screen** (on page 66).
- **Next Page** - Press the **Next Page** option button to show **Mask Page 2/2**.

Mask - Page 2/2

After pressing the **Next Page** option button, **Mask** menu Page 2/2 is shown which contains the following option button controls.

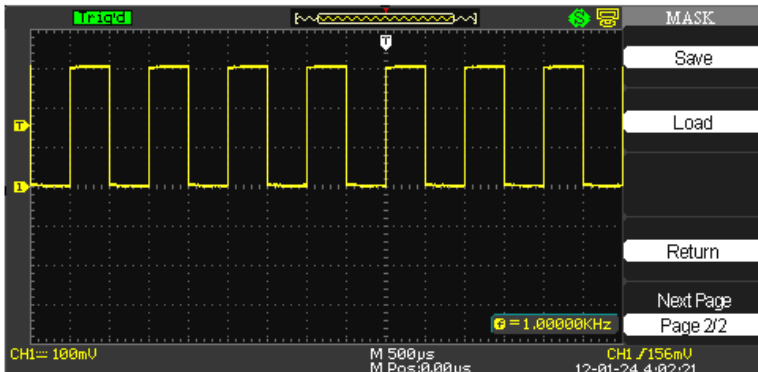

- **Save** - Press the **Save** option button to store your mask. After pressing, the mask is saved **Internally**, or the **SAVE ALL** screen is shown, depending on your **Location** control setting (choose Internal or External as desired on Mask - Page 1/2).
- **Load** - Press the Load option button to retrieve a stored mask. After pressing, the mask is retrieved **Internally**, or the **SAVE ALL** screen is shown, depending on your **Location** control setting (choose Internal or External as desired on Mask - Page 1/2).

- **Return** - Press the Return option and the **Pass/Fail** menu is shown.
4. Press the **Return** option button or the **Utility** front panel button and the **Utility** menu is shown.

Using Record

The **Record** function can record the input waveform from CH1 and CH2 (also, CH3 and CH4 on four channel versions), with a maximum record length of 2500 frames. This keeps you from having to watch the signal when capturing abnormal signals over a long period of time.

Access the **Record** function by pressing the corresponding option button on the **Utility** menu. The **Record** menus are then shown.

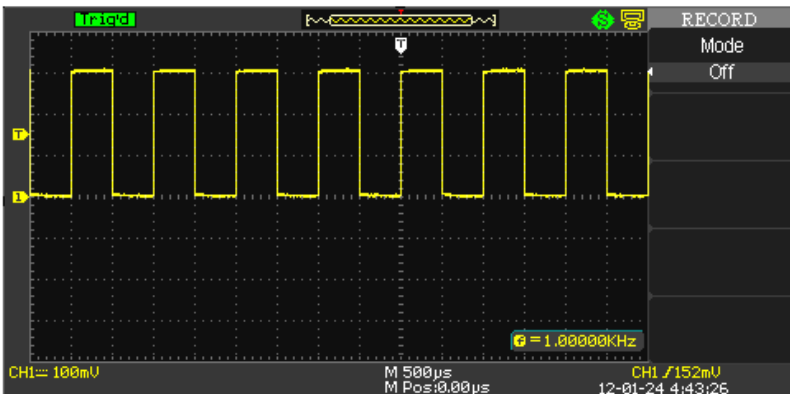

The **Record** function operates in three **Modes**: **Off**, **Record**, and **Playback**. As shown previous, no option button controls are available when the Record's **Mode** is set to **Off**.

Record Menu (with Mode Set to Record)

Press the Mode option button and select **Record**. The Record menu (with Mode set to Record) is shown and contains the following option button controls (in addition to Mode).

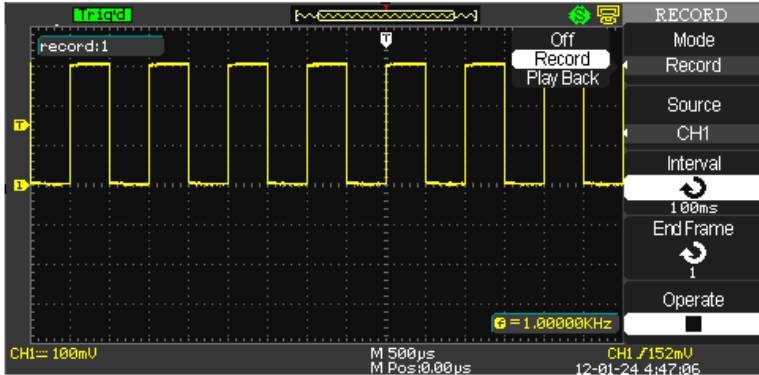

1. Press the **Source** option button to choose from CH1 and CH2 (also, CH3 and CH4 on four channel versions) as the recorded signal input.
2. Press the **Interval** option button and use the **Adjust Front Panel** (on page 7) knob to dial in the desired interval between record frames.
3. Press the **End Frame** option button and use the **Adjust** front panel knob to dial in the desired number of record frames.
4. Press the Operate option button to **Start/Stop** recording.

NOTE: A **record: 1** counter is shown on the upper-left part of the grid display area which counts the number of record frames to your set **End Frame** amount. After pressing the Operate option button, once the End Frame amount is reached, a **Record Wave Success** notification is then briefly shown on the lower-center part of the grid display area.

Record Menu (with Mode Set to Play Back) - Page 1/2

Press the Mode option button and select **Play Back**. The Record menu (with Mode set to Play Back) - Page 1/2 is shown and contains the following option button controls (in addition to Mode).

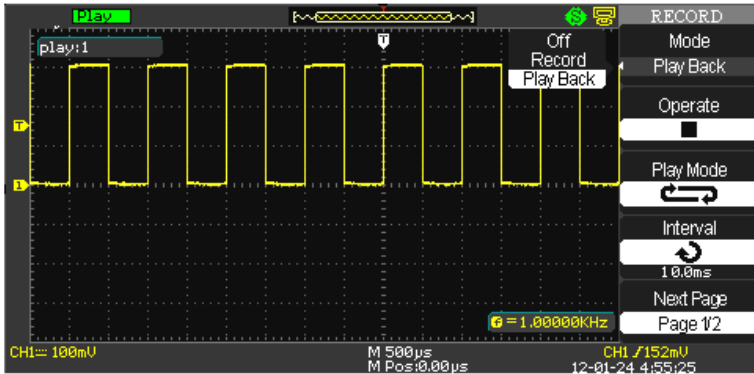

1. Press the Operate option button to **Start/Stop** playback.

NOTE: A **play: 1** counter is shown on the upper-left part of the grid display area which counts the number of record frames to your recorded **End Frame** option button control (set on PlayBack Page 2/2) amount. If your play mode is set to Circular (repeat) the counter continually cycles. Otherwise, if using the Single Time play mode, the counter reaches the end frame amount and stops.

2. Press the **Play Mode** option button to choose from **Circular** (repeat) or **Single time** (play once, and then stop) modes.

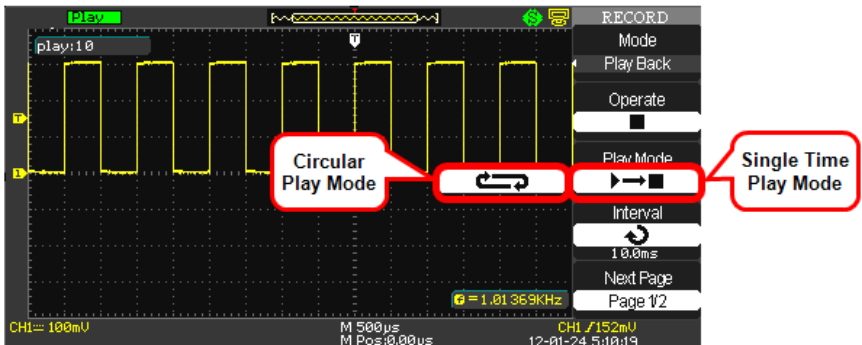

3. Press the **Interval** option button and use the **Adjust** front panel knob to dial in the desired interval between record frames for the playback of your recorded waveforms.

Record Menu (with Mode Set to Play Back) - Page 2/2

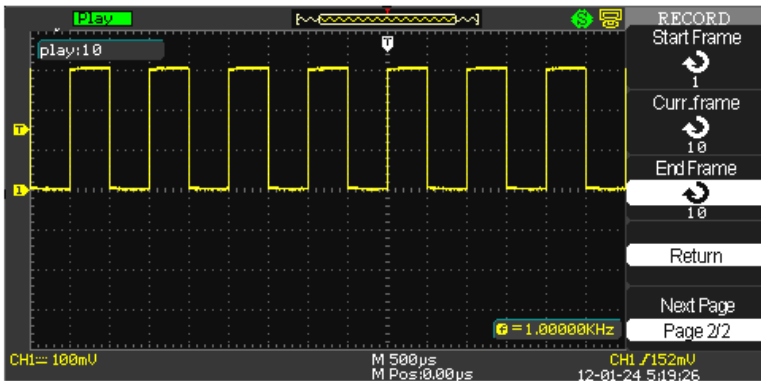

1. After pressing **Next Page** from Page 1/2, press the **Start Frame** option button and use the **Adjust** front panel knob to dial in the specific frame of your recorded waveforms where you want to start the playback.
2. Press the **Curr_Frame** option button and use the **Adjust** front panel knob to dial in the exact frame of your recorded waveforms you want showing on the display grid.
3. Press the **End Frame** option button and use the **Adjust** front panel knob to dial in the specific frame of your recorded waveforms where you want to end the playback.
4. Press the **Return** option button or the Utility **Front Panel** (on page 7) button and the **Utility** menu is shown.

Setting and Displaying the Date/Time

Pressing the Date/Time option button from Utility menu 4/4 shows the DATE/TIME menu with the following option button controls.

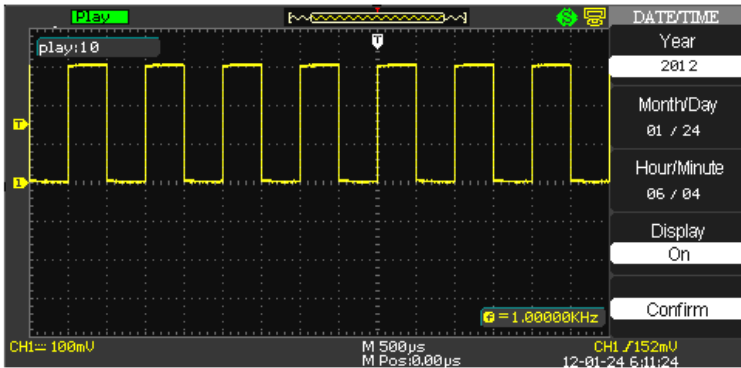

1. Press the **Year** option button and use the Adjust **Front Panel** (on page 7) knob to provide a year value.
2. Press the **Month/Day** option button and the Month is highlighted first. Subsequent presses of the Month/Day option button toggles between highlighting the day or the month. Use the **Adjust** front panel knob to provide the desired respective value.
3. Press the **Hour/Minute** option button and the Hour is highlighted first. Subsequent presses of the Hour/Minute option button toggles between highlighting the minute or the hour. Use the **Adjust** front panel knob to provide the desired respective value.
4. Press the **Display** option button and choose an **On** or **Off** value to show or hide the Date/Time from the lower-right of the display.

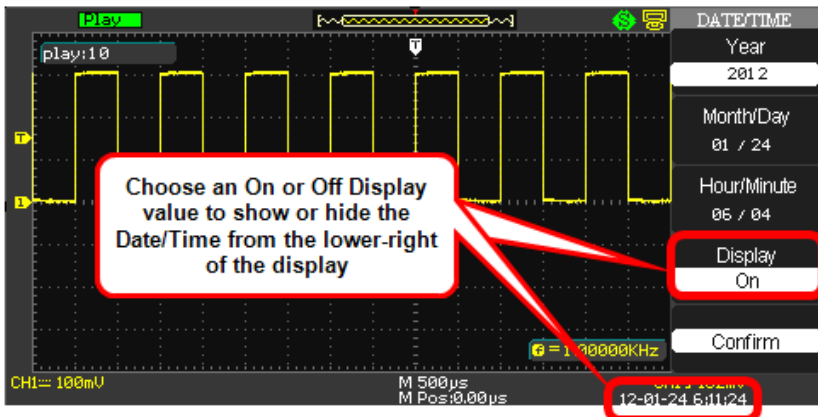

Reference

Using WaveStudio to Remotely Connect to the WaveAce

The following steps demonstrate how to use WaveStudio to remotely connect to your WaveAce oscilloscope.

1. **Make the hardware connection to your oscilloscope.**

Connect a network cable to the RJ-45 connector on the back of your oscilloscope as shown in **Back and Side Connections** (on page 8).

Note: Contact a system administrator when connecting to any internal LAN.

2. **Configure the remote control settings on the oscilloscope to enable remote control.**

Press the **UTILITY Front Panel** (on page 7) button to display the **Utility** menu, and then press the **Next Page** option button to display page 2/4.

Now, press the Back USB option button until **USBTMC** is selected and your oscilloscope is WaveStudio remote connection ready.

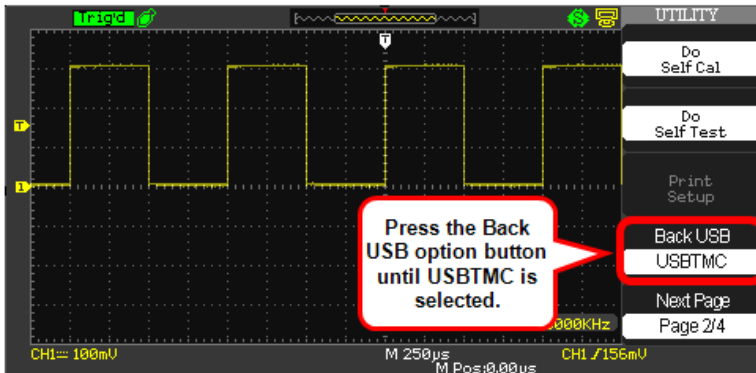

3. **Download and install the National Instruments Measurement & Automation Explorer on your PC.**

Note: Download the program at www.ni.com. When the installation is complete, launch the program and keep it open on your PC.

4. Connect to the remote oscilloscope from Wave Studio.

Now, it's time to launch WaveStudio on your computer.

- With the software launched, select **Add Scope** by clicking the button for this action, which can be found in **The Scope Ribbon**, or using its miniature form on the top portion of the My Scope Explorer (Device) Explorer.

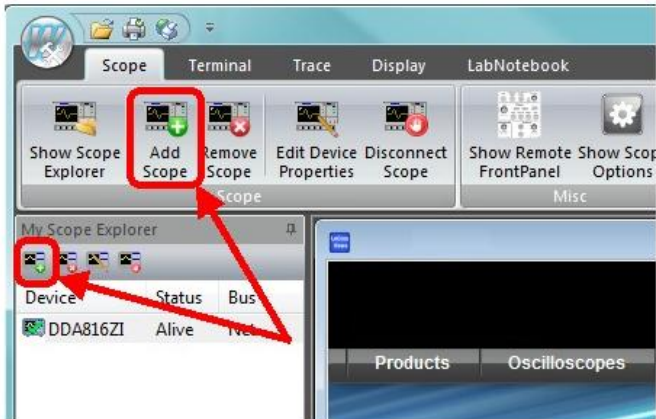

- This opens the **Add Device** pop-up.

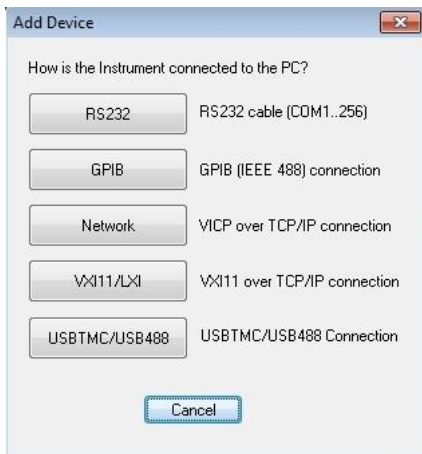

- Click either the **Network** (for WaveAce 2000 models with an RJ-45 connector on the Back Panel) or **USBTMC/USB488** (for either 1000/2000 models using the USB Type B connector) device connection button. See **Back and Side Connections** (on page 8) for more information.

WaveAce 1000/2000

After selecting your device connection, WaveStudio completes the setup and the added device configuration is shown on **The Scope (Device) Explorer** window.

With an established connection, the bottom half of the My Scope (Device) Explorer window shows a tree including items like **Terminal, Front Panel, Scope Options, Traces, Display Capture, Scope Setups, Mass Storage** and **LabNotebook** and is where most WaveStudio features are utilized.

With your WaveAce remotely connected, the R icon is shown on the upper-right area of the screen display and you can only change the state of the instrument from the WaveStudio program.

Press the **Force** front panel button on your WaveAce to disconnect from a WaveStudio remote control session.

NOTE: Access teledynelecroy.com for the complete **WaveStudio** documentation.

WaveAce Specifications

Note: Specifications are subject to change without notice.

Please refer to the Teledyne LeCroy website at teledynelecroy.com or the online help on your Teledyne LeCroy oscilloscope for detailed specification information.

Certifications

This section contains the instrument's Electromagnetic Compatibility (EMC), Safety and Environmental certifications.

EMC Compliance

EC DECLARATION OF CONFORMITY - EMC

The oscilloscope meets intent of EC Directive 2004/108/EC for Electromagnetic Compatibility. Compliance was demonstrated to the following specifications as listed in the Official Journal of the European Communities:

EN 61326-1:2006, EN 61326-2-1:2006 EMC requirements for electrical equipment for measurement, control, and laboratory use.¹

Electromagnetic Emissions:

CISPR 11:2003, Radiated and Conducted Emissions Group 1, Class A ^{2 3}

EN 61000-3-2:2006 Harmonic Current Emissions, Class A

EN 61000-3-3/A2:2005 Voltage Fluctuations and Flickers, Pst = 1

Electromagnetic Immunity:

EN 61000-4-2:2001 Electrostatic Discharge, 4 kV contact, 8 kV air, 4 kV vertical/horizontal coupling planes ⁴

EN 61000-4-3:2006 RF Radiated Electromagnetic Field, 3 V/m, 80-1000 MHz; 3 V/m, 1400 MHz - 2 GHz; 1 V/m, 2 GHz - 2.7 GHz ⁴

EN 61000-4-4:2004 Electrical Fast Transient/Burst, 1 kV on power supply lines, 0.5 kV on I/O signal data and control lines ⁴

EN 61000-4-5:2006 Power line Surge, 1 kV AC Mains, L-N, L-PE, N-PE ⁴

EN 61000-4-6:2007 RF Conducted Electromagnetic Field, 3 Vrms, 0.15 MHz - 80 MHz ⁴

EN 61000-4-11:2004 Mains Dips and Interruptions, 0%/1 cycle, 70%/25 cycles, 0%/250 cycles ^{4 5}

1 To ensure compliance with all applicable EMC standards, high quality shielded interface cables should be used.

2 Emissions which exceed the levels required by this standard may occur when the oscilloscope is connected to a test object.

3 This product is intended for use in nonresidential areas only. Use in residential areas may cause electromagnetic interference.

4 Meets Performance Criteria "B" limits of the respective standard: during the disturbance, product undergoes a temporary degradation or loss of function or performance which is self-recoverable.

5 Performance Criteria "C" applied for 70%/25 cycle voltage dips and for 0%/250 cycle voltage interruption test levels per EN61000-4-11.

European Contact:

Teledyne LeCroy Europe GmbH

Waldhofer Str 104

D-69123 Heidelberg

Germany

Tel: (49) 6221 82700

AUSTRALIA & NEW ZEALAND DECLARATION OF CONFORMITY – EMC

Oscilloscope complies with the EMC provision of the Radio Communications Act per the following standards, in accordance with requirements imposed by Australian Communication and Media Authority (ACMA):

CISPR 11:2003 Radiated and Conducted Emissions, Group 1, Class A, in accordance with EN61326-1:2006 and EN61326-2-1:2006.

Australia / New Zealand Contacts:

Vicom Australia Ltd.

1064 Centre Road

Oakleigh, South Victoria 3167

Australia

Vicom New Zealand Ltd.

60 Grafton Road

Auckland

New Zealand

Safety Compliance

EC DECLARATION OF CONFORMITY – LOW VOLTAGE

The oscilloscope meets intent of EC Directive 2006/95/EC for Product Safety. Compliance was demonstrated to the following specifications as listed in the Official Journal of the European Communities:

EN 61010-1:2010 Safety requirements for electrical equipment for measurement, control, and laboratory use – Part 1: General requirements

EN 61010-2:030:2010 Safety requirements for electrical equipment for measurement, control, and laboratory use – Part 2-030: Particular requirements for testing and measuring circuits

The design of the instrument has been verified to conform to the following limits put forth by these standards:

- Overvoltage Category II: this refers to equipment intended to be supplied from the building wiring with a nominal supply voltage up to 300V.
- Measurement Category O: this refers to oscilloscope measurement terminals that are not intended to be directly connected to the MAINS supply.
- Pollution Degree 2: this refers to an operating environment where normally only dry, non-conductive pollution occurs. Occasionally a temporary conductivity that is caused by condensation must be expected. This location is a typical office/home environment.

- Protection Class I: this refers to grounded equipment, in which protection against electric shock is achieved by Basic Insulation and a connection to the protective ground conductor in the building wiring.

U.S. NATIONALLY RECOGNIZED AGENCY CERTIFICATION

The oscilloscope has been certified by Underwriters Laboratories (UL) to conform to the following safety standard and bears UL Listing Mark:

UL 61010-1 Third Edition – Safety standard for electrical measuring and test equipment.

CANADIAN CERTIFICATION

The oscilloscope has been certified by Underwriters Laboratories (UL) to conform to the following safety standard and bears cUL Listing Mark:

CAN/CSA-C22.2 No. 61010-1-12. Safety requirements for electrical equipment for measurement, control and laboratory use.

Environmental Compliance

END-OF-LIFE HANDLING

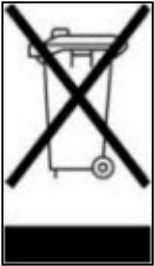

The instrument is marked with this symbol to indicate that it complies with the applicable European Union requirements to Directives 2002/96/EC and 2006/66/EC on Waste Electrical and Electronic Equipment (WEEE) and Batteries. The instrument is subject to disposal and recycling regulations that vary by country and region. Many countries prohibit the disposal of waste electronic equipment in standard waste receptacles. For more information about proper disposal and recycling of your Teledyne LeCroy product, please visit teledynelecroy.com/recycle.

RESTRICTION OF HAZARDOUS SUBSTANCES (ROHS)

This instrument has been classified as Industrial Monitoring and Control Equipment, and is outside the scope of the 2011/65/EU RoHS Directive until 22 July 2017 (per Article IV, Paragraph 3).

ISO Certification

Manufactured under an ISO 9000 Registered Quality Management System. Visit teledynelecroy.com to view the certificate.

Contact Teledyne LeCroy

Teledyne LeCroy Service Centers

<p>United States and Canada - World Wide Corporate Office Teledyne LeCroy Corporation 700 Chestnut Ridge Road Chestnut Ridge, NY, 10977-6499, USA Ph: 800-553-2769 / 845-425-2000 FAX: 845-578-5985 teledynelecroy.com Support: contact.corp@teledynelecroy.com Sales: customersupport@teledynelecroy.com</p>	<p>United States - Protocol Solutions Group Teledyne LeCroy Corporation 3385 Scott Boulevard Santa Clara, CA, 95054, USA FAX: 408-727-0800 teledynelecroy.com Sales and Service: Ph: 800-909-7211 / 408-727-6600 contact.corp@teledynelecroy.com Support: Ph: 800-909-7112 / 408-653-1260 psgsupport@teledynelecroy.com</p>
<p>European Headquarters Teledyne LeCroy SA 4, Rue Moïse Marcinhes Case postale 341 1217 Meyrin 1 Geneva, Switzerland Ph: + 41 22 719 2228 / 2323 /2277 FAX:+41 22 719 2233 contact.sa@teledynelecroy.com applications.indirect@teledynelecroy.com teledynelecroy.com/europe Protocol Analyzers: Ph: +44 12 765 03971</p>	<p>Singapore, Oscilloscopes Teledyne LeCroy Singapore Pte Ltd. Blk 750C Chai Chee Road #02-08 Technopark @ Chai Chee Singapore 469003 Ph: ++ 65 64424880 FAX: ++ 65 64427811 Singapore, Protocol Analyzers Genetron Singapore Pte Ltd. 37 Kallang Pudding Road, #08-08 Tong Lee Building Block B Singapore 349315 Ph: ++ 65 9760-4682</p>
<p>China Teledyne LeCroy Corporation Beijing Rm. 2001 - Office; Rm. 2002 - Service Center Unit A, Horizon Plaza No. 6, Zhichun Road, Haidian District Beijing 100088, China Ph: ++86 10 8280 0318 / 0319 / 0320 FAX:++86 10 8280 0316 Service: Rm. 2002 Ph: ++86 10 8280 0245</p>	<p>Korea Teledyne LeCroy Korea 10th fl. Ildong Bldg. 968-5 Daechi-dong, Gangnam-gu Seoul 135-280, Korea Ph: ++ 82 2 3452 0400 FAX: ++ 82 2 3452 0490</p>
<p>Taiwan LeColn Technology Co Ltd. Far East Century Park, C3, 9F No. 2, Chien-8th Road, Chung-Ho Dist., New Taipei City, Taiwan Ph: ++ 886 2 8226 1366 FAX: ++ 886 2 8226 1368</p>	<p>Japan Teledyne LeCroy Japan Hobunsha Funchu Bldg, 3F 3-11-5, Midori-cho, Fuchu-Shi Tokyo 183-0006, Japan Ph: ++ 81 4 2402 9400 FAX: ++ 81 4 2402 9586 teledynelecroy.com/japan</p>

Index

A

acquisition, 13, 32
 mode, 31
 sampling rate, 31
 sampling types, 29
 Sinx/x, 30
 trigger, 16
 Adjust knob, 10
 alternative triggering, 38
 Auto Setup, 21
 averaging, 29

B

bandwidth limiting, 24

C

calibration, 71
 Quick Cal, 77
 certifications, 92
 channels
 turn on, 18
 cleaning, 5
 contact information, 96
 coupling, 23
 create files/folders, 68
 CSV file, 61
 cursors, 39
 placement, 42
 types, 41

D

data, saving, 61
 date/time setup, 77, 89

default settings, 62
 delay
 parameter, 47
 deskew, 28
 digital filter, 27
 display
 screen saver, 77
 setup, 18
 symbols, 19

E

edge triggering, 34
 equivalent time sampling, 31

F

FFT, 51
 files/folders, creating, 68
 firmware update, 76
 firmware updates, 80
 front panel, 7, 10
 Adjust knob, 10
 Auto button, 13
 Default Setup button, 13
 Help button, 13
 Horizontal controls, 15
 Menu buttons, 11
 Print button, 11
 Run/Stop buttons, 13
 Trigger controls, 16
 Vertical controls, 14

- H**
 - 2-channel, 49
 - 4-channel, 50
- hardware
 - front panel, 7
 - inputs, 8
- Help, 13
- horizontal
 - setup, 15
 - timebase, 32
- I**
 - Intensity knob, 10
 - inverting waveforms, 26
 - IP address, 76
- L**
 - language, 69
- M**
 - maintenance
 - calibration, 71
 - cleaning, 5
 - cooling, 5
 - mask testing, 83
 - math, 49
 - 2-channel models, 49
 - 4-channel models, 50
 - FFT, 51
 - measure
 - cursors, 39
 - parameters, 43
 - memory (reference waveform), 53, 57
 - Menu buttons, 11
 - mode (acquisition), 31
 - models, 2
- N**
 - network address, 76
- O**
 - operating environment, 5
- P**
 - parameters, 43
 - all mea(surement), 48
 - delay, 47
 - time, 46
 - voltage, 44
 - pass/fail testing, 76, 82
 - peak detect, 29
 - play back, 87
 - power
 - consumption, 6
 - ground connections, 6
 - powering on, 9
 - standby, 6
 - print
 - Print button, 11
 - screen, 59
 - setup, 75, 78
 - probe
 - attenuation, 26
 - compensation, 17
 - settings, 26
 - pulse triggering, 35

R

- real time sampling, 31
- record inputs, 76, 85
 - playback, 87
- reference waveforms (memory), 53
- remote control, 90

S

- safety, 3
 - precautions, 4
- sampling
 - mode, 31
 - rate, 31
- save/recall, 54
 - default settings, 62
 - SAVE ALL, 66
 - screen print, 59
 - settings, 54
 - waveform data, 61
 - waveforms, 57
- screen
 - print, 59
 - saver, 77
 - setup, 18
- self test, 73
- sensitivity, 25
- setup, 5
 - Auto Setup, 21
 - default, 13
 - digital filter, 27
 - display, 18
 - operating environment, 5
 - traces, 18

- Sinx/x, 30
- skew, 28
- slope triggering, 37
- software updates, 80
- sound, 69
- specifications, 92
- Spectrum Analyzer, 51
- start up, 9
- system
 - self test, 73
 - status, 69

T

- time
 - parameters, 46
- timebase
 - changing, 32
 - setup, 15
- traces
 - turn on, 18
 - zooming, 32
- trigger
 - alternative, 38
 - edge, 34
 - pulse, 35
 - setup, 16
 - slope, 37
 - types, 34
 - video, 36

U

units, 28

USB port setup, 75, 77

utilities, 69

- date/time setup, 77

- firmware update, 76

- language, 69

- network address, 76

- pass/fail setup, 76

- print setup, 75, 78

- quick calibration, 77

- record input, 76

- screen saver, 77

- Self, 71

- self test, 73, 76

- sound, 69

- system status, 69

- USB port setup, 75, 77

V

vertical

- bandwidth limiting, 24

- coupling, 23

- probe, 26

- sensitivity, 25

- setup, 14, 23

- skew, 28

- units, 28

video triggering, 36

voltage, 6

- cursors, 39

- parameter, 44

W

waveform

- acquiring, 32

- analyzing, 39

- applying math, 49

- inverting, 26

- measuring, 39

- reference, 53

- save/recall, 57

WaveStudio, 90

Z

zooming, 32



TELEDYNE LECROY
Everywhereyoulook™

700 Chestnut Ridge Road
Chestnut Ridge, NY 10977
USA

teledynelecroy.com