

NHD-4.3RTP-SHIELD

4.3" Arduino Shield User Guide

NHD-	Newhaven Display
4.3-	4.3" Diagonal
RTP-	4-wire Resistive Touch Panel with Controller
SHIELD-	Arduino Shield

Newhaven Display International, Inc.

2661 Galvin Ct.

Elgin IL, 60124

Ph: 847-844-8795

Fax: 847-844-8796

www.newhavendisplay.com

nhtech@newhavendisplay.com

nhsales@newhavendisplay.com

Document Revision History

Revision	Date	Description	Changed by
0	09/14/16	Initial Release	PB

Table of Contents

Overview	4
Product Features.....	5
Configuration Options.....	6
Arduino I/O Configuration (SPI)	6
Micro-SD	6
Reset Button	6
Audio Connector	7
Audio Amplifier Mute/Enable Select	7
Power Supply Selection.....	7
Connecting with an Arduino Uno R3.....	8
Installing the Arduino FT800 Library.....	9
Hello World Test	11
Jackpot Test.....	12
Software Support	15
Hardware Support.....	15
Download Links	16

Overview

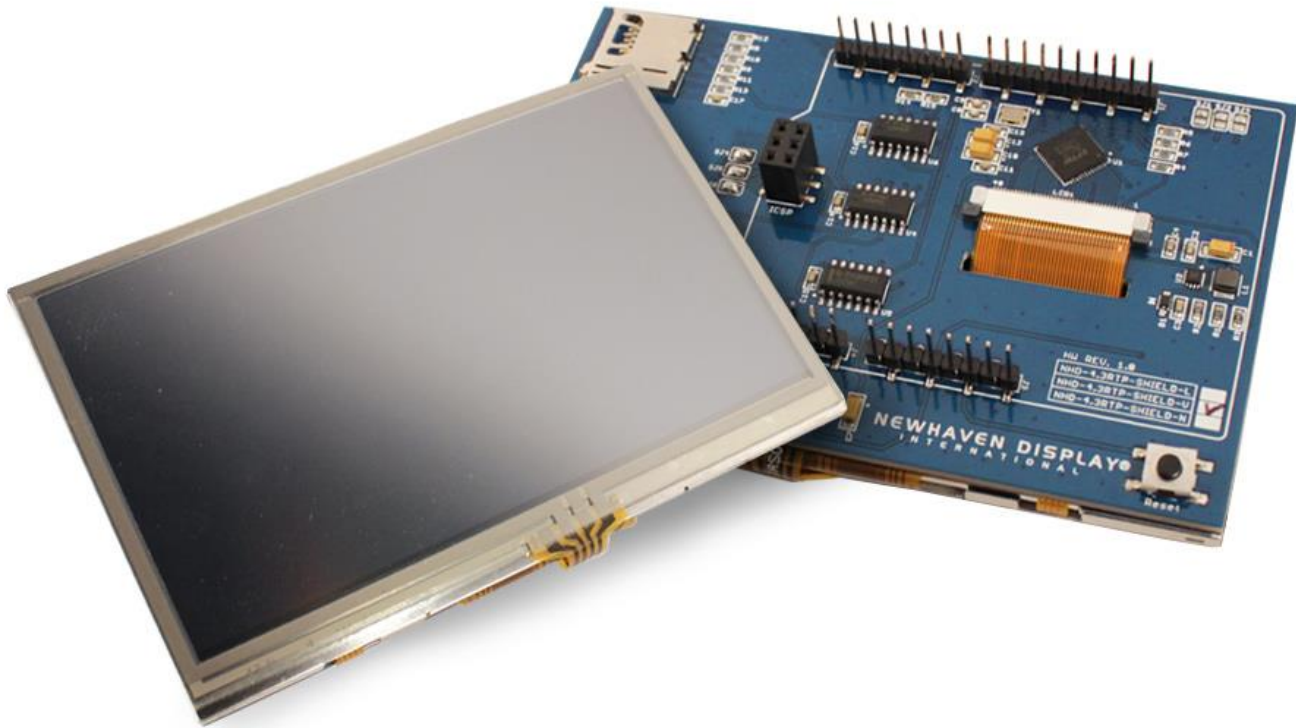

Effortless touch development is obtained with Newhaven Display's new Arduino Shields customized for their 4.3" capacitive or resistive touch TFT display line. Available in six display variations, these shields are ready to mate with some of Arduino's most commonly used development boards. Newhaven Display's 4.3" Arduino Shields are designed to be a simple compact solution for developing with touchscreen capable TFT displays.

The 4.3" Arduino Shields are available in six different models. Each shield features a 480x272 resolution TFT in the form of a Sunlight Readable, Premium (MVA) or Standard LCD display type. In addition to these three different display types, there are two different touchscreen options to choose from: capacitive or 4-wire resistive touch. These shields feature the FT801 (capacitive touch) or the FT800 (resistive touch) embedded video engine by FTDI which may be used to develop and demonstrate the functionality of the FT80X IC's and Newhaven's 4.3" touchscreen TFT displays. A bonus of these shields is the PWM (Pulse Width Modulation) which is the type of digital signal used to control the dimming of backlight LEDs. Since the Arduino Development boards are powerful tools, a micro SD slot also comes as a built-in standard allowing additional storage space for more complex code. This eliminates any memory constraints of the Arduino board. Additionally, the shields generate audio output with an on board power amplifier.

Engineered in Elgin Illinois, these 4.3" Arduino Shields were designed by Newhaven engineers for classic Arduino boards such as Uno, Mega and Leonardo. Each Arduino board connects directly to the back of the shield, greatly reducing software and hardware development time and simplifying the design process. No extra controller boards or messy cables are required, providing a much faster and effortless experience developing with a touchscreen TFT. By utilizing Arduino's vastly growing community, engineers can take advantage of shared code developed by other engineers as well as code created by Newhaven's engineers. To help engineers get started with the 4.3" Arduino Shields, Newhaven Display shares a repository of example code to get any engineer up and running as soon as the product arrives. Additionally, the open source hardware and software design will save engineers time and money. With all of these unique features and more, the 4.3" Arduino Shields are the best and quickest method for developing with touch TFTs.

Product Features

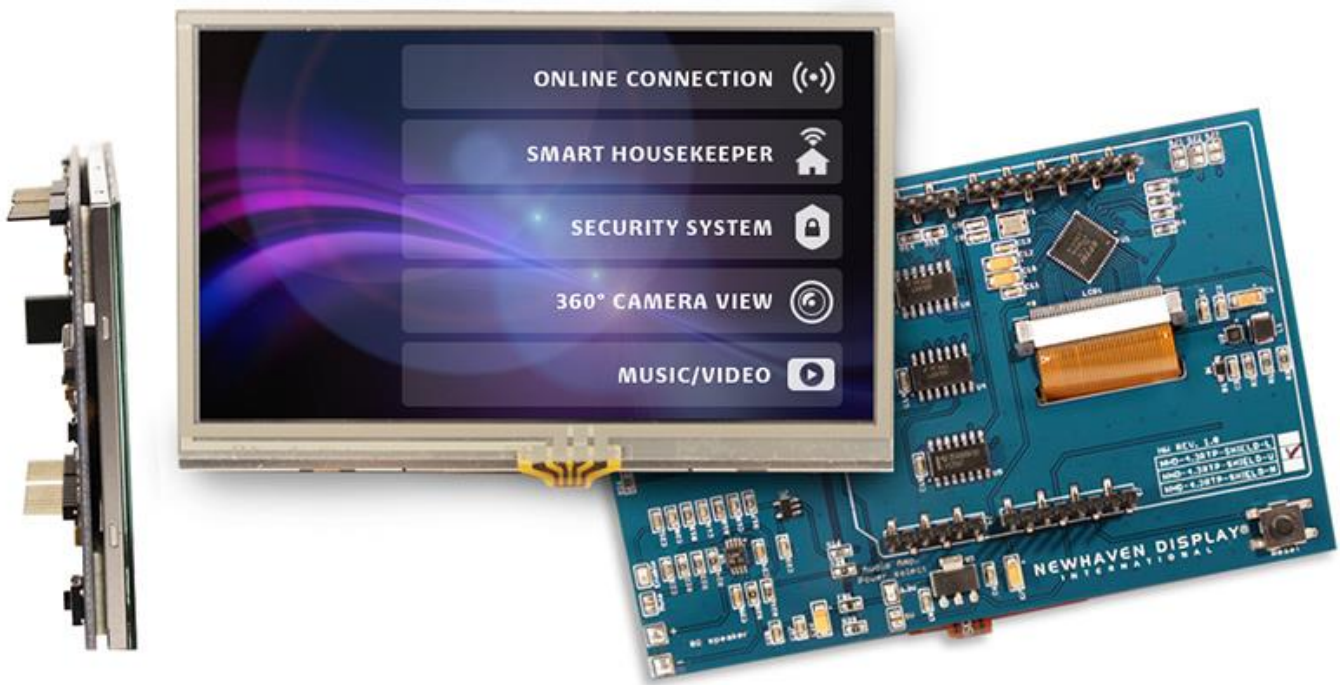

- Connects with Arduino UNO, Mega and Leonardo
- Standard, Premium and Sunlight Readable TFTs
- PWM backlight control
- Open Source Hardware and Software
- Micro SD slot for expandable memory (microSD card not included)
- 5V tolerant buffers
- Supports mono audio output
- On board LCD backlight LED driver
- On board audio power amplifier
- Extremely small form factor
- 4-wire Resistive touch panel

Configuration Options

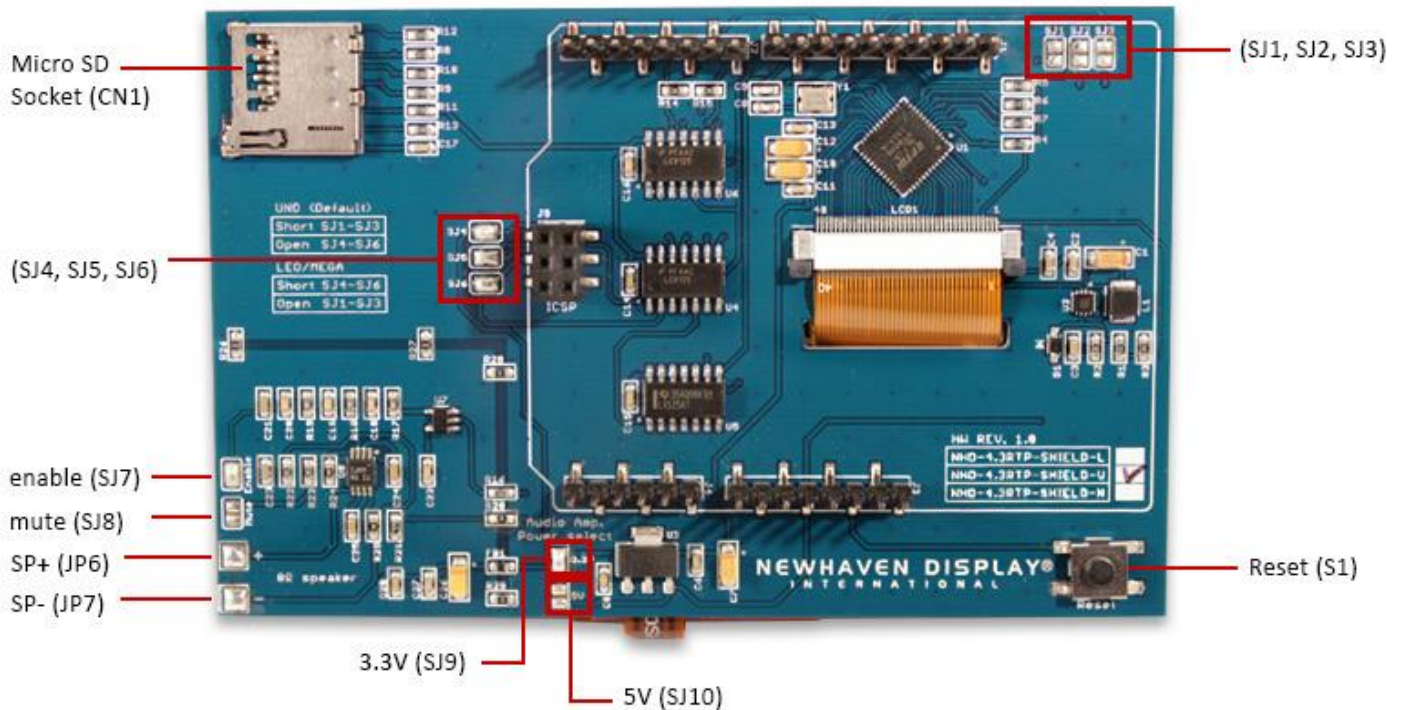

Arduino I/O Configuration (SPI)

On the NHD-4.3RTP-SHIELD, six solder jumpers (SJ1, SJ2, SJ3, SJ4, SJ5, and SJ6) have been added to provide flexibility to the Users' Arduino selection.

Solder Jumpers **SJ4**, **SJ5**, and **SJ6** enable the SPI lines on the ICSP header. The MISO, MOSI, and SCK lines are available in a consistent physical location on the ICSP header (Solder connections fitted by default).

Solder Jumpers **SJ1**, **SJ2**, and **SJ3** enable the SPI lines on the Arduino Uno's Digital header. A number of clones do not include the ICSP header, and therefore this configuration is required to be compatible.

Micro-SD

The micro-SD socket **CN1** on the NHD-4.3RTP-SHIELD enables the Arduino to access files for use with the FT801 Graphics Controller, along with being a storage media for general storage used by the Arduino. The Arduino communicates to both the Display and micro-SD over SPI, and some of the communication from the display may request the Arduino for information which is stored on a file on the micro-SD card. The Arduino will then access the information on the micro-SD card and send the information to the Display.

Reset Button

S1 is a reset button for the Arduino, not for the display. This allows access to the Arduino's reset button which is covered up when a shield is placed on top of the Arduino for a number of the Arduino models.

Audio Connector

The audio connector is used for connecting an external speaker 8 Ohm 1 Watt.

JP6 (SP+) Audio speaker +ve from the onboard amplifier.

JP7 (SP-) Audio speaker -ve from the onboard amplifier.

Audio Amplifier Power Select

This jumper provides the option to select the power supply voltage for the onboard power amplifier.

SJ9 (3.3V) Audio Amplifier Power Select 3.3 Volts (Solder connection fitted by default).

SJ10 (5V) Audio Amplifier Power Select 5 Volts.

Audio Amplifier Mute/Enable Select

This jumper provides the option to Enable or Mute the onboard amplifier.

SJ7 (Enable) Audio Amplifier Enable (Solder connection fitted by default).

SJ8 (Mute) Audio Amplifier Mute.

Power Supply Selection

Since you'll probably be connecting other things to the Arduino (LEDs, sensors, servos) you should get an adapter that can supply at least 500mA, or even 1000 mA. That way you can be sure you have enough juice to make each component of the circuit function reliably.

Our advice is to stick with a 7V - 8V DC adapter.

Connecting with an Arduino Uno R3

To use, simply place the Shield onto your Arduino Uno as shown below.



Slowly remove the protective film on the display by pulling up on the tab.

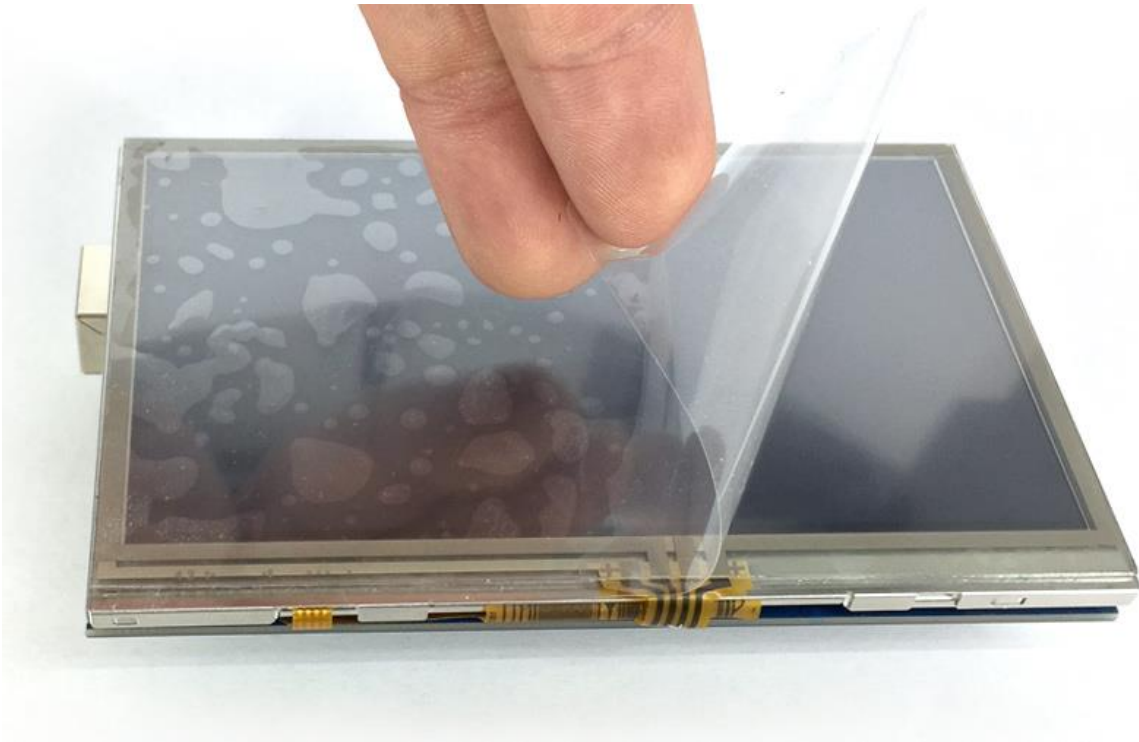

Installing the Arduino FT800 Library

FTDI has an Arduino library with example code ready to go for use with the NHD-4.3RTP-SHIELD. You will need to download the library first and install it.

Visit Newhaven Display’s GitHub page and download the Arduino specific library for the FT800.

https://github.com/NewhavenDisplay/FTDI_FT800

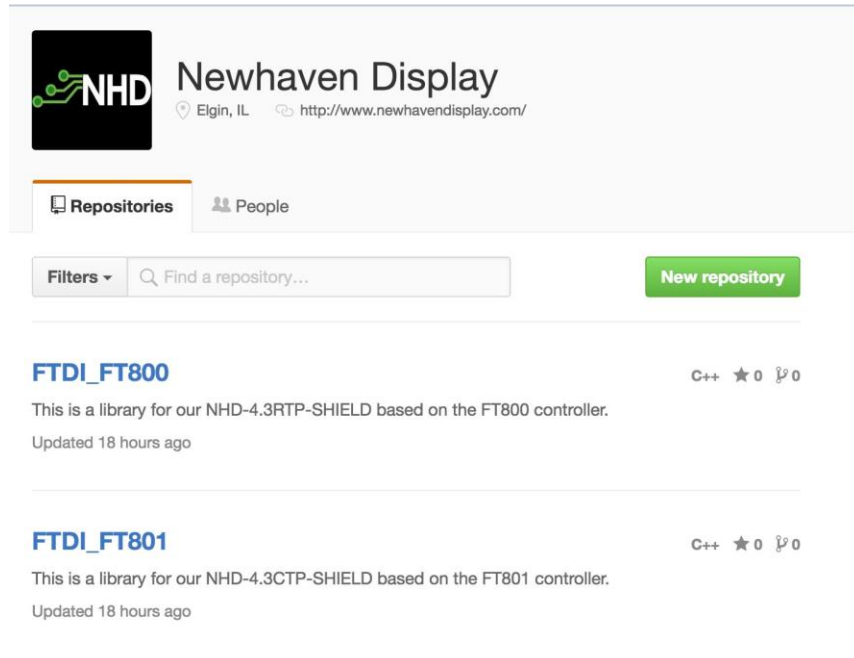

When you are on the project page, you can press the “Download ZIP” button which is located under the “Clone or download” drop down. Click on that button, and the browser will download the library to your computer.

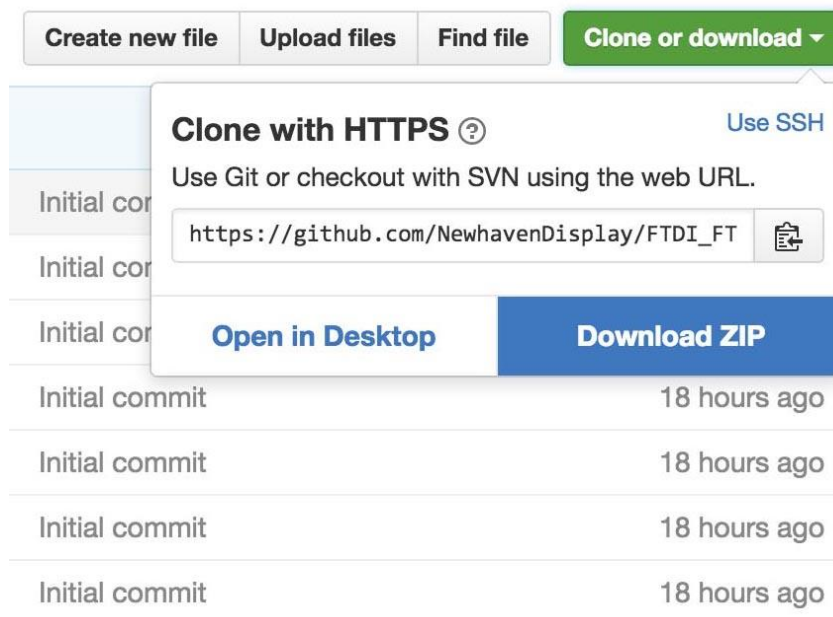

Uncompress the folder and rename it “FTDI_FT800” make sure that inside that folder is the FT_NHD_43RTP_SHIELD.h file. Then copy it to your arduinosketchfolder/libraries folder. For more details, especially for first-time library installers, check out the following tutorial at <https://www.arduino.cc/en/Guide/Libraries>

Restart the Arduino software. You should see a new example folder called “FTDI_FT800” and inside, a collection of sample projects.

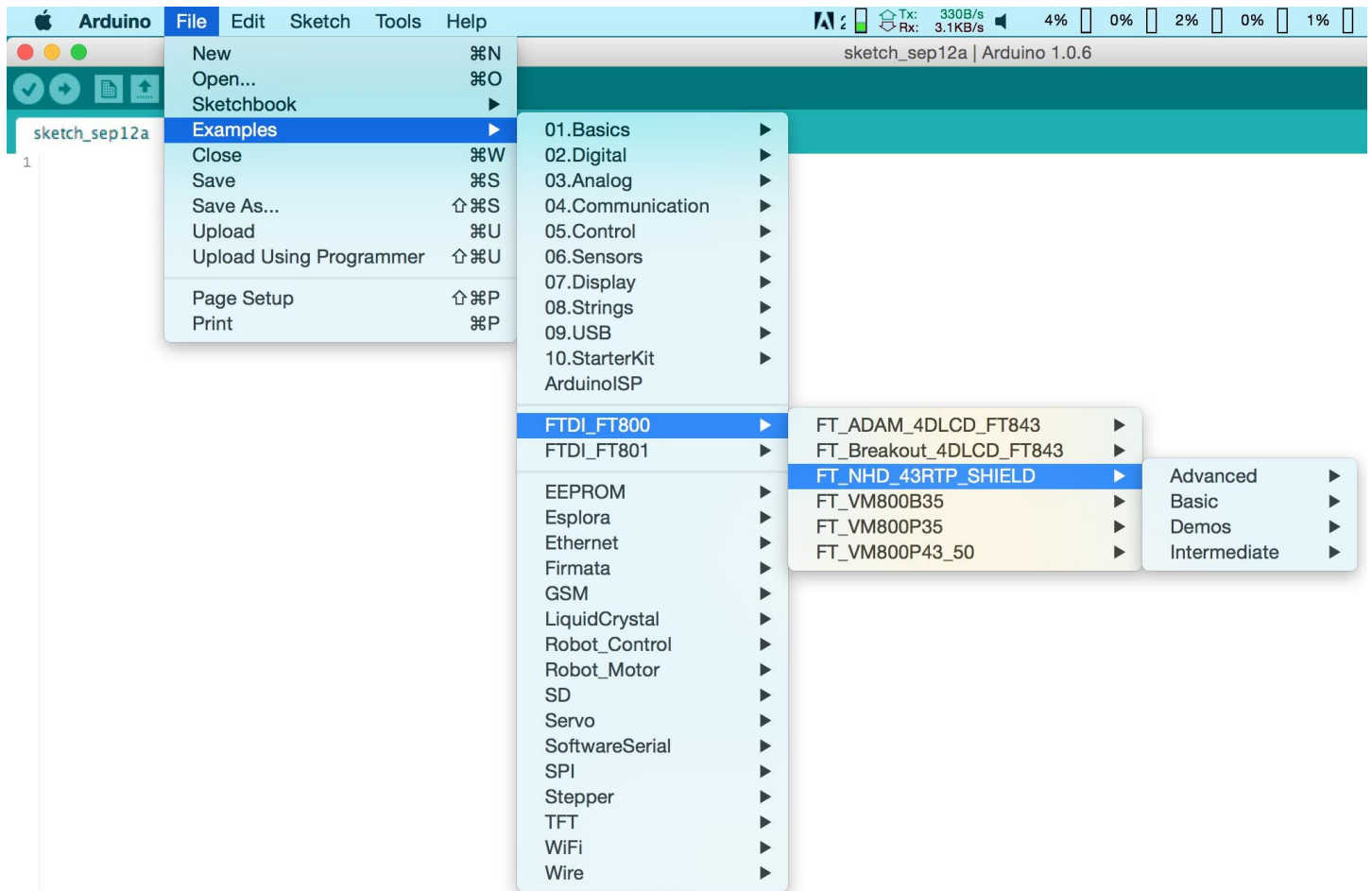

Hello World Test

This is the example sketch to display hello world on the NHD-4.3RTP-SHIELD.

Select the following sketch and upload it to your Arduino.

“File → Examples → FTDI_FT800 → FT_NHD_43RTP_SHIELD → Basic → HelloWorld”

When the Arduino restarts, you should see the following:



Jackpot Test

This application is a custom version of a Slot Machine game and it demonstrates the usage of built-in FT800 widgets and primitives, manipulating bitmaps and playing audio.

This application makes use of the micro-SD socket **CN1** on the NHD-4.3RTP-SHIELD to access files for use with the FT800 Graphics Controller.

To display bitmaps from the on-board micro SD slot, you will need a micro SD card.



The on-board audio amplifier is also utilized in this application. The audio connector will be used for connecting an external speaker 8 Ohm 1 Watt.

JP6 (SP+) Audio speaker +ve from the onboard amplifier.

JP7 (SP-) Audio speaker -ve from the onboard amplifier.



First copy the bitmap files from the FTDI_FT800/examples/FT_App_Jackpot/SDCard folder to the root directory of your micro-SD card.

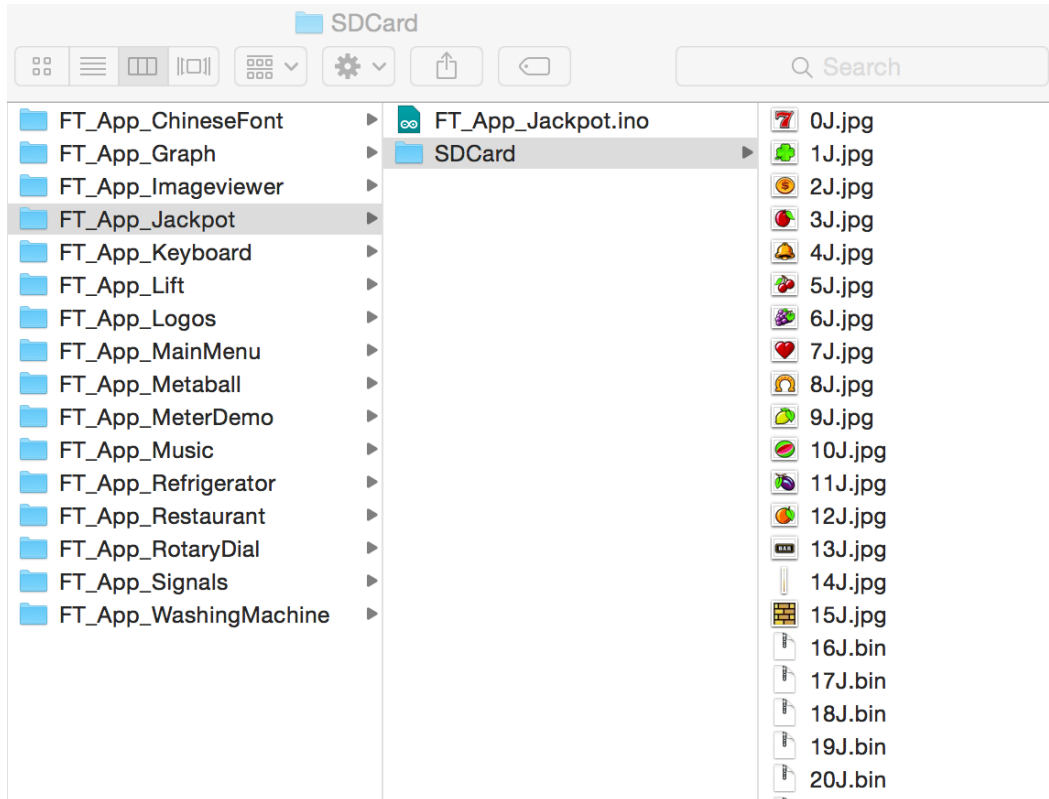

Insert the micro SD card into the slot on the back of the NHD-4.3RTP-SHIELD breakout board.

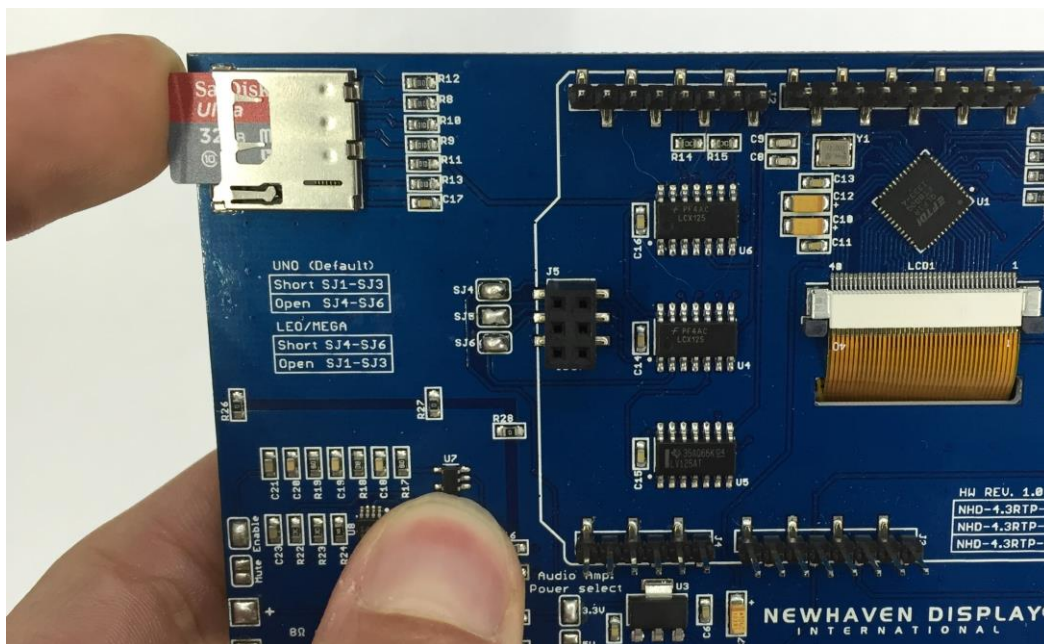

Solder your 8 Ohm 1 Watt speaker to **JP6(SP+)** and **JP7 (SP-)**. Be sure to check for shorts and cold solder joints.

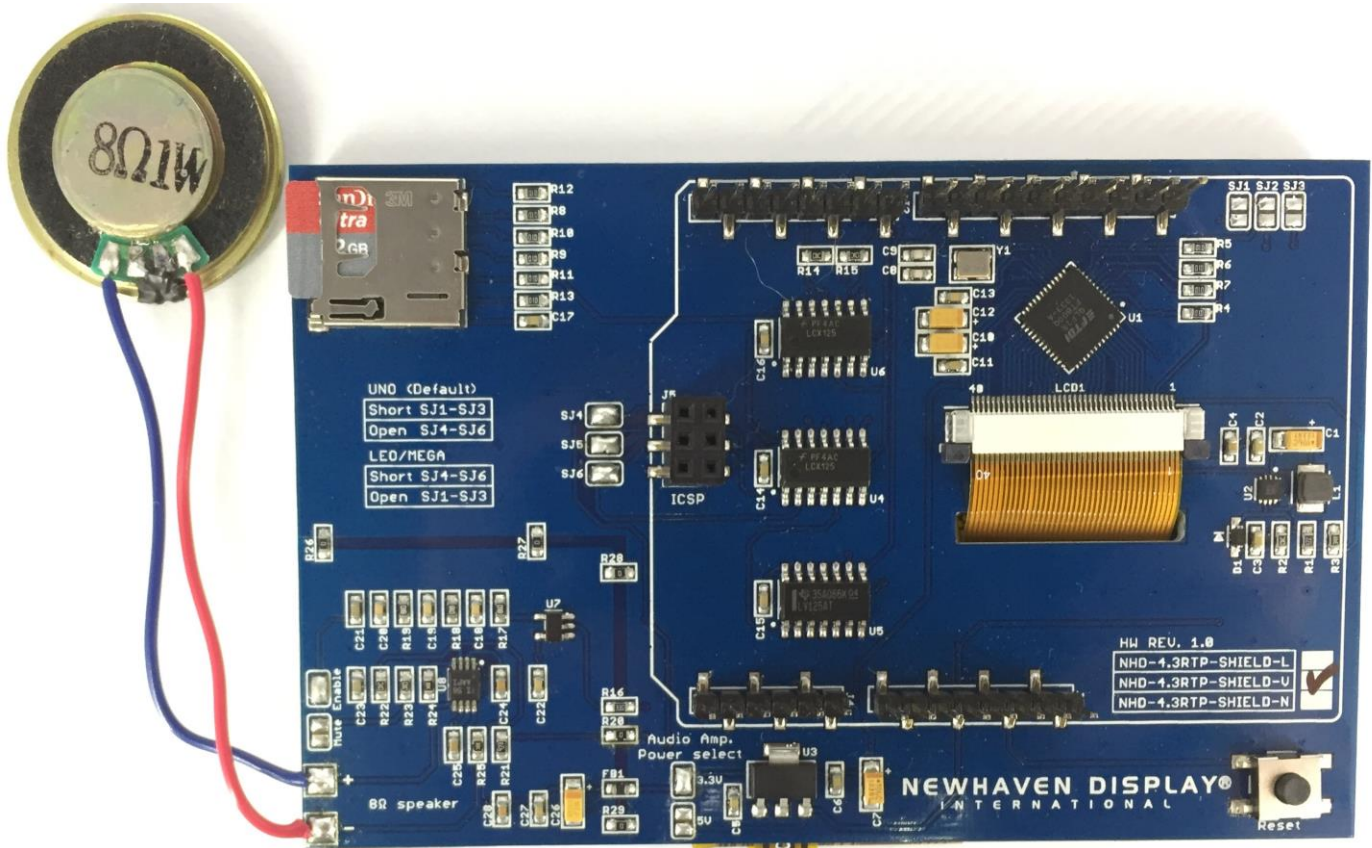

Select the following sketch and upload it to your Arduino.

“File → Examples → FTDI_FT800 → FT_NHD_43RTP_SHIELD → Demos → FT_App_Jackpot”

When the Arduino restarts, you should see the following:

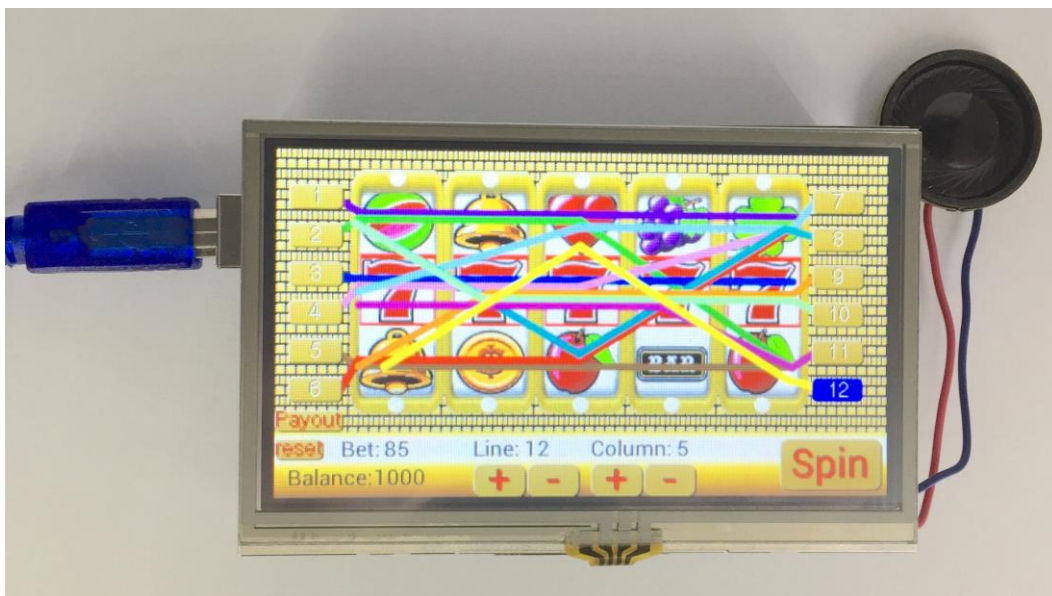

Software Support

All software relating to the NHD-4.3RTP-SHIELD and the Arduino are supplied from FTDI Directly, and are not created nor maintained by Newhaven Display International Inc.

Newhaven Display has created the NHD-4.3RTP-SHIELD hardware, however all software relating to these products are provided by FTDI. For any additional software support relating to these products, please contact the FTDI Support team, <http://www.ftdichip.com/FTContact.htm>.

Hardware Support

The NHD-4.3RTP-SHIELD hardware is supported by Newhaven Display. Any issues regarding the hardware itself, please contact the Newhaven Display Support team via the Newhaven Display website, or on the Newhaven Display Forum (also accessible from the Newhaven Display website). <http://www.newhavendisplay.com/>

Compatible Arduino's

The NHD-4.3RTP-SHIELD is compatible with a wide range of Arduino and Arduino clones, however there are some which are not compatible. The NHD-4.3RTP-SHIELD requires 5V to be supplied from the Arduino itself, and some Arduino clones, specifically 3.3V versions such as the Arduino Pro 3.3V, feature 3.3V on the pin typically specified as being 5V. These 3.3V varieties are not compatible as 5V is required for the NHD-4.3RTP-SHIELD itself.

Known compatible Arduino's for the NHD-4.3RTP-SHIELD:

Uno

NerO

Leonardo

Mega 2560

(Others may be compatible also)

Download Links

FT800 Library Download:

FT800 Library

[http://www.ftdichip.com/Support/SoftwareExamples/EVE/FTDI_V1.4.0_03272015\(FT800\).zip](http://www.ftdichip.com/Support/SoftwareExamples/EVE/FTDI_V1.4.0_03272015(FT800).zip)

NHD-4.3RTP-SHIELD Datasheets:

NHD-4.3RTP-SHIELD-L Datasheet

<http://www.newhavendisplay.com/specs/NHD-4.3RTP-SHIELD-L>

NHD-4.3RTP-SHIELD-V Datasheet

<http://www.newhavendisplay.com/specs/NHD-4.3RTP-SHIELD-V>

NHD-4.3RTP-SHIELD-N Datasheet

<http://www.newhavendisplay.com/specs/NHD-4.3RTP-SHIELD-N>

Built-in FTDI FT800 Embedded Video Engine.

Please download specification at http://www.ftdichip.com/Support/Documents/DataSheets/ICs/DS_FT800.pdf

Programmers Guide:

FT800 Series Programmer Guide

<http://www.ftdichip.com/Support/Documents/ProgramGuides/FT800%20Programmers%20Guide.pdf>

Image File Conversion Guide:

FT800 Image File Conversion Guide

http://www.ftdichip.com/Support/Documents/AppNotes/AN_303%20FT800%20Image%20File%20Conversion.pdf

Audio File Conversion Guide:

FT800 Audio File Conversion Guide

http://www.ftdichip.com/Support/Documents/AppNotes/AN_276%20FT800%20Audio%20File%20Conversion.pdf

Precautions for using LCDs/LCMs:

See Precautions at <http://www.newhavendisplay.com/specs/precautions.pdf>

Warranty Information

See Terms & Conditions at http://www.newhavendisplay.com/index.php?main_page=terms