



2017-2018

**INDUSTRIAL
NETWORKING
PRODUCTS**

Engineered and
manufactured
in Taiwan

Contents



Industrial Networking

Introduction	04
ATOP's Added Experience	05

Industry-Specific Ethernet Switches

Power Networking: IEC 61850-3	24
IEC61850-3 DIN-Rail Managed Switches	25
IEC61850-3 Rackmount, HSR/PRP, PTP BC	26
EN 50155 – Railway Networking	28
EN 50155 – Railway Unmanaged Switches	32
EN 50155 – Railway Managed Switches	33

Entry level Switches

Unmanaged Entry-Level Switches	11
Unmanaged Smart Secure Switches	12
Unmanaged Gigabit PoE Switches	13

Industrial Wireless

Industrial Wireless Devices	34
-----------------------------	----

Harsh Environment Switches

Introduction	14
Unmanaged Harsh Environment Switches	15
Layer-2 Managed DIN-Rail Switches	16
Layer-3 Managed Switches	19
Rack-mount Managed Switches	21
Modular Concept	22
Switch Core Platforms	22
Modules	23

Media Converters

Media Converters	35
------------------	----





Serial Device Servers

Introduction	36
Use them as Embedded Computers!	36
Entry Level Serial Device Servers	37
Wireless / Cellular Serial Device Servers	38
Advanced Serial Device Servers	39
IEC61850-3 – Serial Device Servers	41
EN 50155 – Railway Specific Serial Servers	41

Appendix: How to read the Brochure

Appendix: How to read the Brochure	42
------------------------------------	----

Industrial Networking



Introduction

Championed as the Fourth Industrial Revolution, Industry 4.0 is an emerging business practice that is set to revolutionize manufacturing with the creation of the Smart Factory. Eliminating inefficiencies and responding to individual consumer demand, the Smart Factory makes use of interconnected advanced robotics, Big Data Analytics, and Industrial Connectivity and Services.

Much of what underpins this revolution is the use of Industrial Ethernet-based networks. But although Ethernet has become the new backbone standard of Industrial Automation, Serial-based devices still remain highly relevant today. So by connecting legacy devices with the latest equipment, existing industries can take advantage of the latest improvements in technological efficiencies without resorting to inefficient wholesale upgrades.

With over 25 years of experience, ATOP has built a reputation for developing and manufacturing networking hardware that delivers solutions to the problems that Industries face in adopting the latest standards and industry innovations, such as incorporating Industry 4.0 and IIoT practices into networks that still rely on Serial-based devices.

Informed by our experience of providing for our customers from a variety of different industries, our range extends from entry level to high-performance hardware that operate in the harshest of environments and the under the most demanding network loads. So in addition to supplying reliable, secure, and cost-effective hardware, our Industrial Ethernet switches feature advanced security features such as redundancy (through RSTP, ERPS, MRP Rings or High Availability protocols such as HSR/PRP), QoS, VLAN management, LACP link aggregation/port trunking, and Layer-3 routing.





ATOP's Added Experience

With over 25 years of experience, ATOP has built a reputation for developing and manufacturing hardware that performs reliably in harsh environments, that offers security and encryption, and that has the performance and fast response to make sure that your network performs and delivers under any circumstances.

Reliability

With MTBF of up to 25 years, ATOP's range of hardware is built to minimize downtime events. Built-in redundancy features such as Ethernet Ring Protection Switching (ERPS), Rapid Spanning Tree Protocol (RSTP) and Media Redundancy Protocol (MRP) ensure ideal upkeep times.

For instance, in the event of a link or device failure, ATOP's Smart-Redundancy Feature detects the failure and relays the cause of the failure to the control center, automatically recovering from the failure to provide continuous operation.

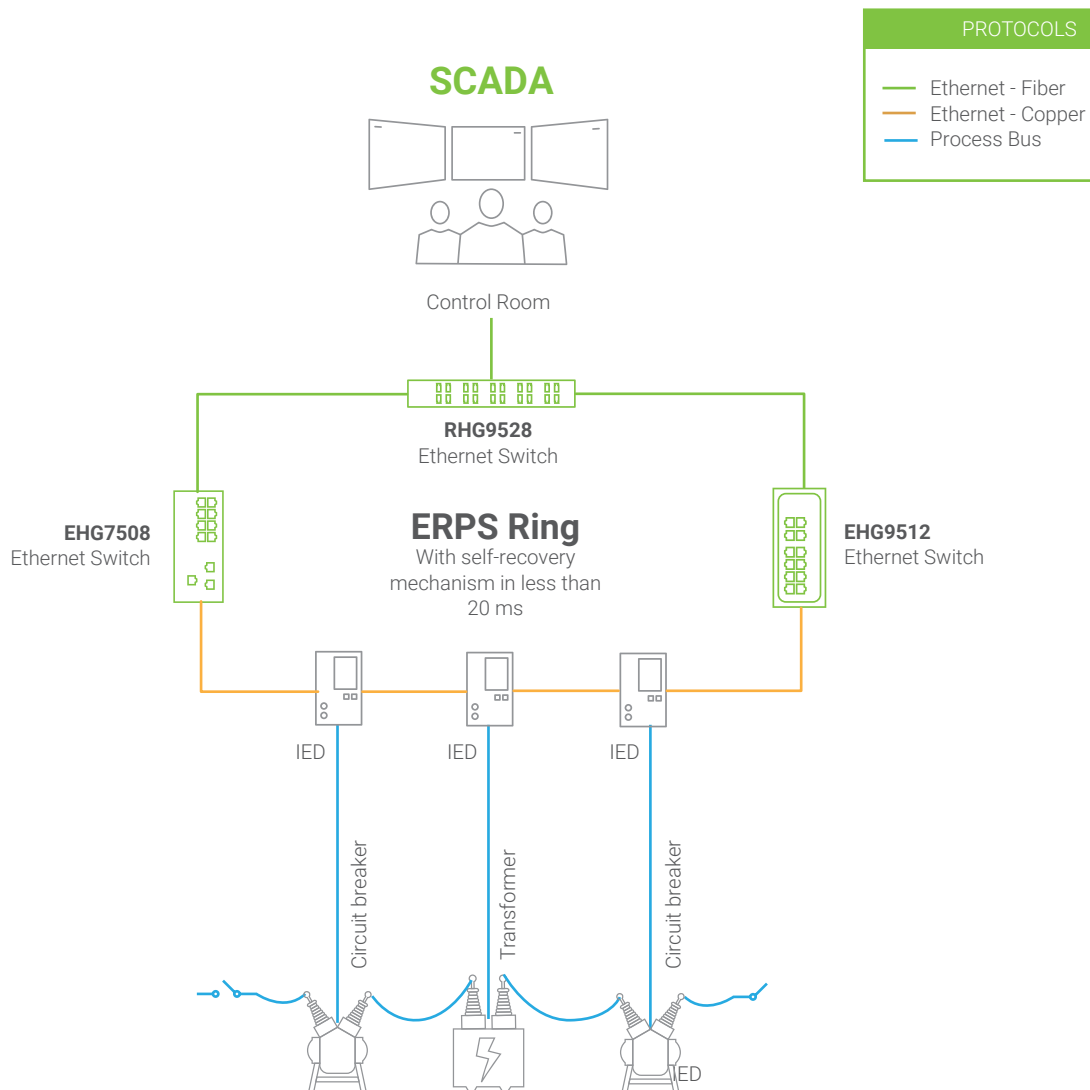

FEATURED PRODUCTS



EHG7508 : Industrial 8-Port PoE Managed Gigabit Switch (-20~70 °C)

- 8 10/100/1000 RJ45 ports or 1000 SFP slots
- maximum 8 x 30 W PoE ports (240W power budget)
- Profinet CC-B compatible; Ethernet/IP; ERPS, RSTP, STP, MRP Client redundancy;
- IEEE 1588v2 Hardware-assisted TC and many others



EHG9512 : IEC 61850-3 12-Port Managed Gigabit Switch (-40~85 °C)

- 8 x 10/100/1000 RJ45 ports and 4 Gigabit SFP uplink slots
- IEC 61850-3, IEEE 1613 certified
- UL/cUL/IEC(CB) 61010-2-201 certified
- IEEE 1588v2 Hardware-assisted TC; ERPS, RSTP, STP, MRP Client redundancy;



RHG9528 : IEC 61850-3 modular Managed Switch, max 24 Gigabit and 4 x 10 GbE ports (-40~85 °C)

- 3 x 8-port Gigabit module slots and 4x 1 or 10 Gigabit SFP uplink slots
- Available modules: 8 x 10/100/1000 RJ45 or 8 x 100/1000 SFP
- IEC 61850-3, IEEE 1613, UL/cUL/IEC(CB) 61010-2-201 certified
- IEEE 1588v2 Hardware-assisted TC; ERPS, RSTP, STP, MRP Client redundancy;



Harsh Environments

From blast furnaces to operating in sub-zero degree environments, ATOP's line of hardware is designed to withstand the harshest of environments. Supporting temperatures range of -40°C to $+85^{\circ}\text{C}$, our hardware uses industrial-grade materials to guarantee also a long MTBF. And because our devices feature fanless designs to reduce the number of moving parts, breakdowns and failures are reduced, thereby prolonging the operational lifetime of your investment.

Electromagnetic Interference and Susceptibility

High-voltages and electromagnetic interferences in factories can be fatal if installed devices are not properly shielded and isolated from electromagnetic discharges. **Without proper precautions, equipment failures become possible** – for instance, a 2,000-Volt surge applied to a power supply unit can cause severe system damage. Devices should also be designed in a way so as to not interfere with their surrounding equipment, as their own radiated emissions can generate noise and interference.

ATOP's hardware conforms with high Electromagnetic Susceptibility (EMS) and Electromagnetic Interference (EMI) standards. And that's in addition to conforming with Level 3 and Level 4 Electromagnetic Compatibility (EMC), making ATOP's hardware compliant with the strictest regulations for susceptibility and interference – such as UL61010, UL60950 and EN61000-6-2 and EN61000-6-4.



Network Security and Data Encryption

With more and more devices coming online, security for Industry 4.0 and IIoT is a pressing issue. The more devices that can be remotely controlled in smart factories, the more points of entry become susceptible to various threats and malicious activities, such as network penetration, which can disrupt operations or threaten the control of systems themselves.

To combat this, ATOP's hardware features security solutions to provide seamless and cost-effective security and encryption: MACsec for security over LANs; and IPsec and OpenVPN for security over WANs and the Internet.

MACsec (or IEEE 802.1AE protocol) enhances your network with hop-to-hop AES 128-bit encryption, and defines how Public and Private keys are managed. If both connected devices support MACsec, then Encryption Key is automatically negotiated from a Pre-Shared Key, or set manually. From that point on, all data transferred through the link will be encrypted at the source with high performance computing hardware to guarantee full bandwidth utilization and decryption on arrival. If the other end does not support MACsec, the data will be transmitted without encryption, meaning that backwards compatibility is still offered.

ATOP is a pioneer in the security of network devices. We have introduced a whole new range of products. This includes, Managed L2 and L3 switches, and a cost-effective unmanaged smart and secure switch. With the 128-bit encryption managed through hardware our solutions provide a seamless experience and unprecedented performance.

ATOP's Routers and Serial device servers provide embedded security measures, through VPNs using IPsec encryption, so that all data going in and out of devices can be properly protected from potential attacks.

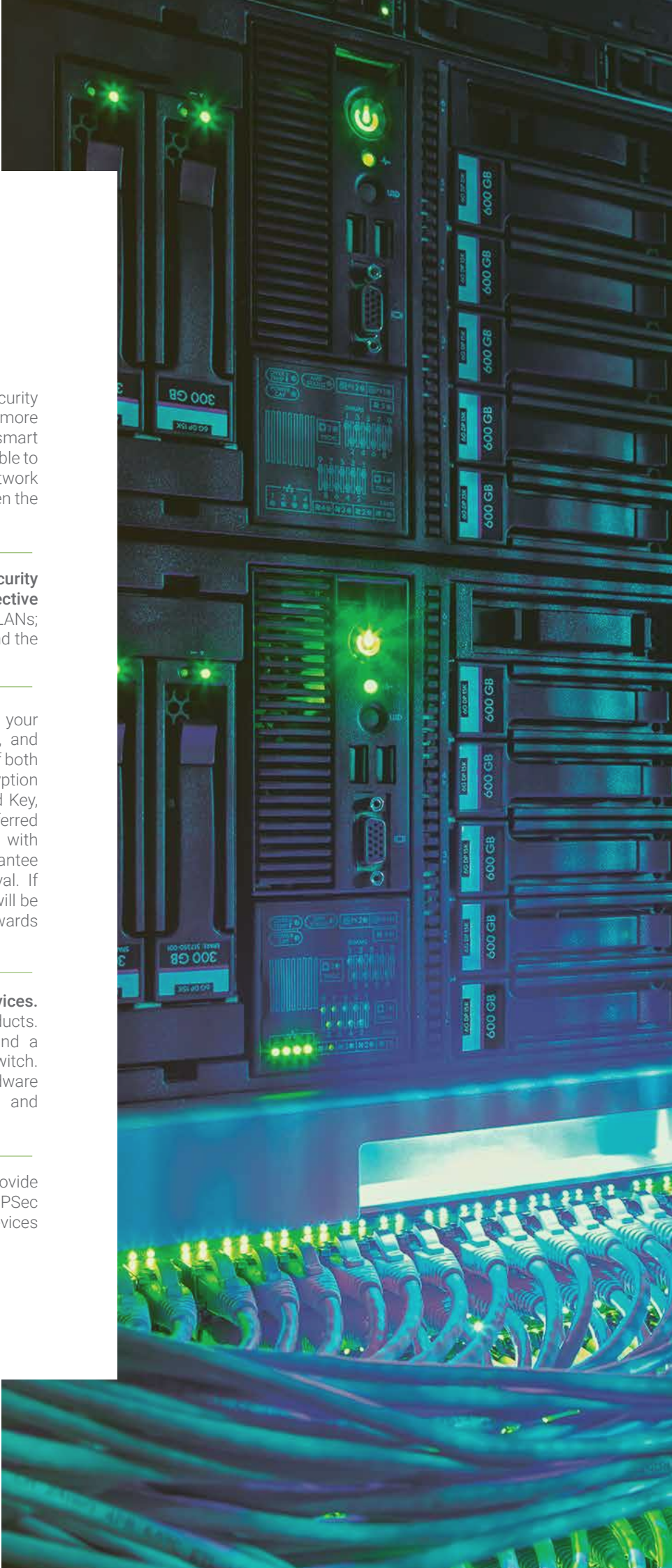

Performance and Responsiveness

Integrating new network hardware with legacy network equipment can often be difficult. For instance, new technologies offer much wider bandwidths and have stricter performance requirements, so integration can be a slow process when trying to match performance discrepancies, such as differences in speed or data throughput.

ATOP is able to solve these types of problems in several ways. For example, our new network devices can autonomously poll data from legacy network devices and store them in an internal memory. A master device running on a newer protocol or higher physical layer can then request the updates at a later point. This helps to reduce bottlenecks, while also increasing system performance.

...our Application Example

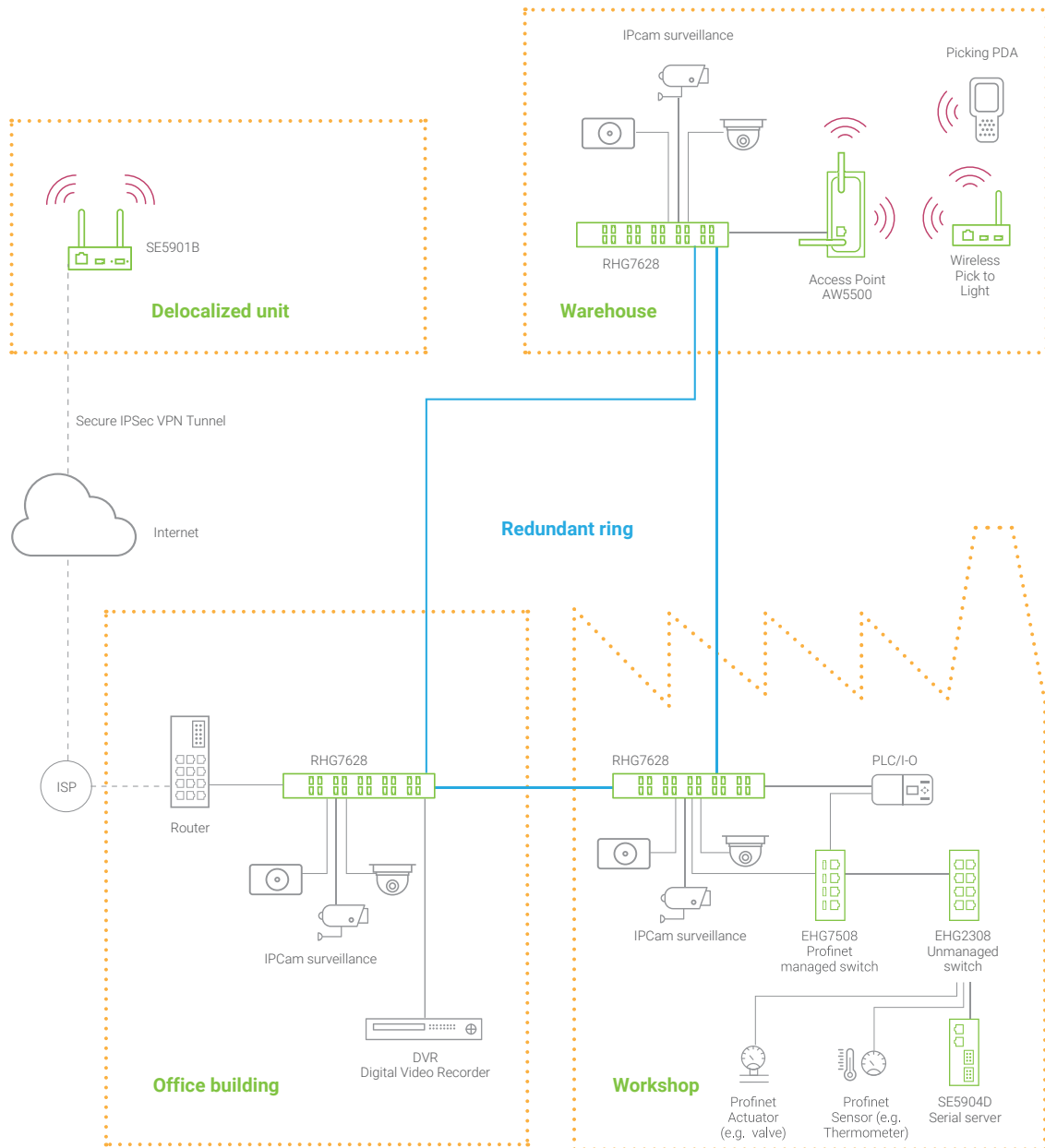

PROTOCOLS	
	Copper or Fiber Ethernet
	Wireless
	10 Gigabit Ethernet Fiber backbone

...more information on our Application Example

RHG7628 - Layer-3 Modular Gigabit Managed PoE Rack-Mount Switch

- Modular architecture for up to 24 Gigabit ports and 4x1 or 4x10 Gigabit Ethernet uplink SFP slots.
- Flexible configuration allows PoE, RJ45, SFP, secure RJ45-SFP ports to be embedded in one device.
- Up to 24 PoE/PoE+ 802.3af-802.3at ports, with maximum 720 W power budget
- -40~75 °C Operating temperature. CE/FCC certified and UL/cULus listed.
- Profinet Conformance Class B v2.33 certified
- Redundancy through ERPS/RSTP/STP/MSTP/MRP (client) protocols
- IEEE 1588v2 hardware-based End-to-End transparent clock



EHG7508 - DIN-Rail 8-Port Managed Gigabit Ethernet PoE switch

- 8 Gigabit ports, in different RJ45/PoE/SFP configurations.
- Up to 8 802.3af 802.3at PoE/PoE+ ports allowing 240 W maximum PoE power Budget
- -20~70 °C Operating temperature. CE/FCC certified and UL/cULus listed
- Profinet Conformance Class B v2.33 certified
- Redundancy through ERPS/RSTP/STP/MSTP and MRP (client).
- Redundant power supply and relay output.



EHG2308 - DIN-Rail 8-Port Unmanaged Gigabit Ethernet switch

- 8-Gigabit RJ45 ports
- -10~70 °C Operating temperature
- Profinet packet prioritization according to 802.1p
- UL/cULus listed
- Redundant power input



SE5901B - DIN-Rail 3G/4G LTE Industrial Serial Device Server

- One Gigabit RJ45 port
- One sw-selectable RS-485/232 serial port
- Battery Feature [opt] provides up to 30s additional power for alarm relay in case of power failure
- 2 Digital inputs / 2 Relays [optional]
- -40~75 °C Operating temperature



AW5500 - DIN-Rail IEEE 802.11 a/b/g/n high-performance Access Point

- IEEE 802.11 abgn radio, supporting 2 x 2 MIMO, 2.4 and 5.0 GHz
- One 10/100/1000 RJ45 Ethernet port
- -10~60 °C Operating temperature
- Different operating mode and Topology Options (WDS Bridge and AP Client)



Entry Level Switches

Unmanaged Entry-Level Switches

ATOP's Entry Level Unmanaged Switches offer a reliable, robust, and cost-effective solution for simple network topologies.

Rated IP30, all of them are Industrial EMC-certified: EN610006-4 and EN61000-6-2. Utilising either aluminum, steel, or plastic housing to suit different application environments and budgets, all models support redundant power-input for enhanced safety and feature DIN - Rail mounting. They can operate in temperatures ranging from -10°C to 70°C (units with plastic housing can operate within a range of 0°C to 60°C). For enhanced safety and backup, redundant power supplies feature on every model.

Our products feature 4 to 8 Fast Ethernet or Gigabit Ethernet ports. Selected versions have single-mode or multi-mode Fiber optic uplink, and selected versions feature Power over Ethernet (PoE) and Gigabit speeds. And as unmanaged switches, they require no configuration efforts. Selected products support Packet Prioritization for Profinet according to 802.1p.



Unmanaged Fast-Ethernet Switches, DIN-Rail mount, Plastic Housing



SKU	Description	10/100 RJ45 ports	10/100 /1000 RJ45 ports	Fiber ports	Max PoE Ports	Additional features
	EH2005-Fm	5-Port Unmanaged Switch with Fiber Optics, plastic	4	-	1 multi-mode max 2 Km	-
	EH2005-Fs	5-Port Unmanaged Switch with Fiber Optics, plastic	4	-	1 Single-mode max 20 Km	-
	EH2006	6-Port Unmanaged Switch, Plastic	6	-	-	-

Unmanaged Fast-Ethernet Switches, DIN-Rail mount, Metal Housing



SKU	Description	10/100 RJ45 ports	SFP slots	Fiber ports	Max PoE Ports	Additional features
	EH2305-1Fm	5-Port Unmanaged Switch with Fiber Optics, Metal Housing	4	-	1 (Multi-Mode) – max 2 Km	-
	EH2305-1Fm	5-Port Unmanaged Switch with Fiber Optics, Metal Housing	4	-	1 (single-mode) – max 20 Km	-
	EH2306	6-Port Unmanaged Switch, Metal housing	6	-	-	-
	EH2308	8-Port Unmanaged Switch, Metal housing	8	-	-	Profinet CC-A
	EH2304-PR	4-Port Unmanaged switch, Metal slim housing	4	-	-	Profinet CC-A, Profinet connectors
	EH2308-PR	8-Port Unmanaged switch, Metal housing	8	-	-	Profinet CC-A, Profinet connectors

Unmanaged Gigabit Ethernet Switches, DIN-Rail mount, Metal Housing



SKU	Description	10/100 RJ45 ports	10/100 /1000 ports	Fiber ports	Max PoE Ports	Additional features
 EHG2308	8-Port Unmanaged switch, Metal housing	-	8	-	-	Profinet packet prioritization according to 802.1p

Unmanaged Smart Secure Switches

ATOP's Unmanaged Smart Secure Switch is most cost-effective solution for bringing security to your network without having to worry about any configurations. Its embedded CPU will handle a hassle-free key-negotiation with hosts automatically from a properly-set Pre-Shared Key, so that users does not have to access the switch personally to key in any configurable parameters to get going. ATOP's Gigabit Unmanaged Smart and Secure Switch is embedded with 6 x 10/100/1000 RJ45 ports and 2 x 10/100/1000 Secured RJ45 or SFP ports, which can work with devices that don't support MACsec.

Unmanaged Gigabit Ethernet Secure Switches, DIN-Rail mount, Metal Housing



SKU	Description	10/100 RJ45 ports	100 SFP slots	10/100 /1000 RJ45 ports	1000 SFP slots	Max PoE Ports	Additional features
 EHG2408	8 port Unmanaged gigabit switch with 2 secure RJ45 ports, Metal Housing	-	-	8 *	-	-	Prioritizes Profinet packets
EHG2408-2SFP	8 port Unmanaged gigabit switch with 2 secure SFP slots, Metal Housing	-	-	6	2	-	Prioritizes Profinet packets

* The 2 uplink ports out of the 8 ports available is MACsec capable

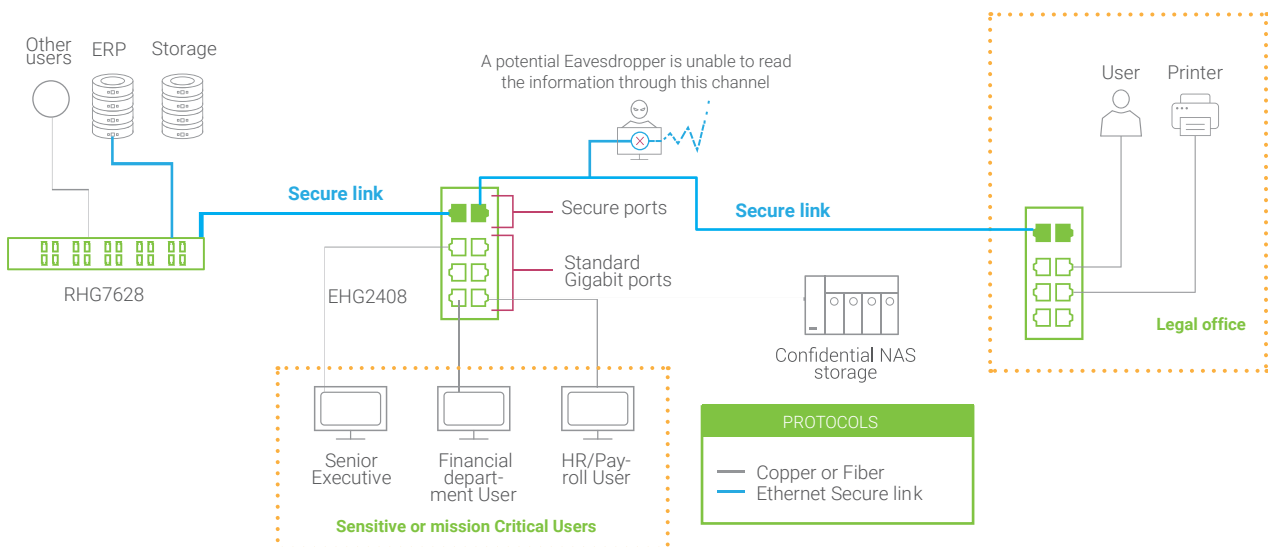

Unmanaged Gigabit PoE Switches

ATOP's Entry Level DIN-Rail mount unmanaged switch is enhanced with Power-over-Ethernet (PoE) and Gigabit SFP technologies, making them ideal for simple industrial applications. **Both 802.3af and 802.3at standards are supported, and each device provides up to 30W power budget per port.** And along with an embedded redundant DC power input, each device can operate in temperatures between -10°C to 70°C.

Unmanaged Gigabit Switches with PoE, DIN-Rail mount, Metal Housing



SKU	Description	10/100 RJ45 ports	100 SFP slots	10/100 /1000 RJ45 ports	1000 SFP slots	Max PoE Ports	Additional features
 EHG6308-4PoE	8-Port Unmanaged Gigabit Switch with 4 PoE Ports, Metal Housing	-	-	8	-	4	
EHG6308-4PoE-4SFP	8-Port Unmanaged Gigabit Switch with 4 PoE Ports and 4 SFP Uplinks	-	-	4	4	4	

...more information on our Application Example

RHG7628 - Layer-3 Modular Gigabit Managed PoE Rack-Mount Switch



- Modular architecture for up to 24 Gigabit ports and 4x1 or 4x10 Gigabit Ethernet uplink SFP slots.
- Flexible configuration allows PoE, RJ45, SFP, secure RJ45-SFP ports to be embedded in one device.
- Up to 24 PoE 802.3af-802.3at ports, with maximum 720 W power budget
- -40~75 °C operational temperature. CE/FCC certified and UL/cULus listed.
- Profinet Conformance Class B v2.33 certified
- Redundancy through ERPS/ RSTP/MRP (client) protocols
- IEEE 1588v2 hardware-based End-to-End transparent clock

EHG2408 - DIN-Rail 8-Port Smart Secure Unmanaged Gigabit switch



- 6-Gigabit non-Secure RJ45 ports
- 2-Gigabit Secure MACsec RJ45 ports or SFP slots
- Simple plug-and-play security
- -10~70 °C operational temperature
- prioritization according to 802.1p
- UL/cULus listed
- Redundant power input

Harsh Environments Switches

Introduction

ATOP's most advanced product line offers hundreds of different possible configurations. Our Harsh Environment switches are the best choice to support highly demanding networks – and in highly demanding environments.

They feature 4 to 28 Fast Ethernet, Gigabit or 10 Gigabit ports, an operating temperature range from -20°C to 70°C or wider, PoE/PoE+ ports equipped with Relay Output, Redundant power input, Profinet Packet Prioritization according to 802.1p (for Unmanaged Switches), and Profinet CC-B v2.33 certification (Managed Switches). Selected products offer MIL-STD shock and vibration certification, and performance in high humidity and can operated in temperature ranges of -40°C to +75°C.

ATOP's Managed Switches provide advanced network management for maximizing network performance and minimizing downtimes. Our Managed Switches use ERPS, RSTP, STP, MSTP and MRP (Client) to minimize such downtimes. They have the ability to manage networks efficiently through embedded SNMP, QoS, VLAN, and they can provide Precision time synchronization with support for IEEE 1588v2 PTP.

Featuring rack-mounted configurations and modular architectures, our switches are easy to customize for your specific application. The same hardware platform can accommodate three different modules to allow the flexibility to choose from 4 powerful 10 x Gigabit Ethernet SFP uplink ports or 4 x Gigabit Ethernet SFP uplink ports.

ATOP Layer-3 Switches provide an ideal solution for scaling up industrial networks. They support IPv4 Static Routing, Dynamic Routing, RIPv1 and RIPv2, OSPFv2, and multicast protocols such as PIM-DM, PIM-SM, DVMRP and IGMPv1, IGMPv2, and IGMPv3. And for high level network security, MACsec Protocol can be used.



Unmanaged Harsh Environments Switches

ATOP's advanced unmanaged switches provide rugged and solid networking solutions for deployment in harsh environments, and offer easy plug-and-play installation, making them quick and easy to install in environments that are less forgiving.

The key features of this series are the availability of 5 to 10 Fast Ethernet or Gigabit Ethernet ports, embedded Power over Ethernet (PoE) on selected models, and a variety of port configurations – such as RJ45, SFP, and single- or multi-mode fiber optics. And with **UL Class 1 Division 2 Certification plus ATEX Zone 2** certification, this series is more than suitable for use in locations like mines – environments that have a high risk of explosion.

Unmanaged Gigabit Switches with/without PoE, DIN-Rail mount Metal Housing



SKU	Description	10/100 /1000 RJ45 ports	1000 SFP slots	Max PoE Ports	Additional features
	EHG7305	5-Port Unmanaged Harsh-Env. Gigabit ATEX Switch	5	-	-
	EHG7306-1SFP	6-Port Unmanaged Harsh-Env. Gigabit ATEX switch with 1 SFP uplink	5	1	-
	EHG7307-2SFP	7-Port Unmanaged Harsh-Env. Gigabit ATEX switch with 2 SFP uplink	5	2	-
	EHG7305-4PoE	5-Port Unmanaged Harsh-Env. Gigabit ATEX switch with 4 PoE Ports	5	-	4
	EHG7306-4PoE-1SFP	6-Port Unmanaged Harsh-Env. Gigabit ATEX switch with 1 SFP uplink and 4 PoE Ports	5	1	4
	EHG7307-4PoE-2SFP	7-Port Unmanaged Harsh-Env. Gigabit ATEX switch with 2 SFP uplink and 4 PoE Ports	5	2	4
					UL Class 1 Division 2 / ATEX Zone 2 certified



Layer-2 Managed DIN-Rail Switches

ATOP's advanced Layer-2 (L2) managed Ethernet switches for harsh environments provide rugged and reliable solutions for managing advanced networks. This series of switches offers a high degree of link redundancy, flow control, and configurability for your network. All models are designed to conform with the strictest Level 3 and Level 4 EMC compliance requirements. Our high-performance components guarantee real-time packet switching, even on full load.

They are available in Fast-Ethernet and Full-Gigabit Ethernet versions, with configurations of 4 to 20 ports, with RJ45 or SFP connector, and optional PoE support. ATOP's L2 managed switch family supports:

Redundancy Protocols

- IEEE802.1D for Spanning Tree Protocol (STP)
- IEEE802.1w/ IEEE802.1D:2004 for Rapid Spanning Tree Protocol (RSTP)
- ITU-T G.8032 ERPS Ring
- IEC 62439-2 MRP - Media Redundancy Protocol (Client)

Time Synchronization

- NTP (Network Time Protocol) Client/ Server
- SNTP (Simple Network Time Protocol) Client
- IEEE1588v2 (Precision Time Protocol) hardware assisted End-to-End transparent clock or IEEE1588v1/v2 sw-assisted boundary clock (selected versions embed IEEE1588v2 hardware boundary clock, with a high precision oscillator)
- ITU-T G.8261 Synchronous Ethernet (selected versions only)

Management

- HTTP/HTTPS (Hypertext Transfer Protocol) configuration
- SNMP (Simple Network Management Protocol) v1/v2c/v3
- Telnet
- Serial Console
- LLDP (Link Layer Discovery Protocol)
- RMON (Remote Monitoring)
- Syslog
- IPv4, IPv6
- DHCP (Dynamic Host Configuration Protocol) Client
- TFTP (Trivial File Transfer Protocol)
- SMTP (Simple Mail Transfer Protocol)
- ARP (Address Resolution Protocol)

Traffic Optimization

- IEEE802.1q for VLAN Tagging
- IEEE802.1p for Class of Service
- IEEE802.3ad for Port Trunk with Link Aggregation Control Protocol (LACP)
- IGMP (Internet Group Management Protocol) v1/v2/v3
- GVRP (GARP VLAN Registration Protocol)
- ICMP (Internet Control Message Protocol)

Security

- IEEE802.1x for Authentication
- RADIUS (Remote Authentication Dial-In User Service)
- EAP

Automation

- Profinet CC-B v2.33 Certified (selected versions)
- Modbus/TCP
- Ethernet/IP

Industrial Managed Fast-Ethernet PoE Switches, DIN-Rail mount



SKU	Description	10/100 RJ45 ports	10/100 /1000 RJ45 ports	10/100 /1000 SFP slots	1/10 GbE SFP slots	Max PoE Ports
	EH7506-2SFP	6-Port Managed Fast-Ethernet Switch, 2 SFP	4	-	2	-
	EH7506-4PoE-2SFP	6-Port Managed Fast-Ethernet Switch with 4 PoE and 2 SFP	4	-	2	4
	EH7508-4G-4SFP	8-Port Managed Fast-Ethernet Switch with 4 Gigabit Combo uplink ports	4	(4)	(4)	-
	EH7508-4G-4PoE-4SFP	8-Port Managed Fast-Ethernet Switch with 4 Gigabit Combo uplink ports	4	(4)	(4)	4
	EH7512-4G-4SFP	12-Port Managed Fast-Ethernet Switch with 4 Gigabit Combo uplink ports	8	(4)	(4)	-
	EH7512-4G-4PoE-4SFP	12-Port Managed Fast-Ethernet Switch with 4 Gigabit Combo uplink ports and 4 PoE ports	8	(4)	(4)	4
	EH7512-4G-8PoE-4SFP	12-Port Managed Fast-Ethernet Switch with 4 Gigabit Combo uplink ports and 8 PoE ports	8	(4)	(4)	8
	EH7520-4G-4SFP	20-Port Managed Fast-Ethernet Switch with 4 Gigabit Combo uplink ports	16	(4)	(4)	-
	EH7520-4G-4PoE-4SFP	20-Port Managed Fast-Ethernet Switch with 4 Gigabit Combo uplink ports and 4 PoE ports	16	(4)	(4)	4
	EH7520-4G-8PoE-4SFP	20-Port Managed Fast-Ethernet Switch with 4 Gigabit Combo uplink ports and 8 PoE ports	16	(4)	(4)	8

Industrial Managed Gigabit PoE Switches, DIN-Rail mount



SKU	Description	10/100 RJ45 ports	10/100 /1000 RJ45 ports	1000 SFP slots	1/10 GbE SFP slots	Max PoE Ports
	EHG7504	4-Port Managed Gigabit Switch	-	4	-	-
	EHG7504-4PoE	4-Port Managed Gigabit Switch with 4 PoE ports	-	4	-	4
	EHG7504-2SFP	4-Port Managed Gigabit Switch with 2 SFP slots	-	2	2	-
	EHG7504-2PoE-2SFP	4-Port Managed Gigabit Switch with 2 SFP slots and 2 PoE ports	-	2	2	2
	EHG7504-4SFP	4-Port Managed Gigabit Switch with 4 SFP slots	-	-	4	-
	EHG7508	8-Port Managed Gigabit Switch	-	8	-	-
	EHG7508-4SFP	8-Port Managed Gigabit Switch with 4 SFP slots	-	4	4	-
	EHG7508-4PoE-4SFP	8-Port Managed Gigabit Switch with 4 SFP slots and 4 PoE ports	-	4	4	4
	EHG7508-8PoE	8-Port Managed Gigabit Switch with 8 PoE ports	-	8	-	8

Industrial Managed Gigabit PoE Switches, DIN-Rail mount

NEW
2018 Q1

-40°C 70°C

PROFI
NET

IEEE 1588

Ring

Industrial EMC



DIN

MILD-STD 810F

IP30 IEC60529

IP30 IEC60529

IP30 IEC60529

SKU	Description	10/100 RJ45 ports	10/100 /1000 RJ45 ports	100/1000 SFP slots	1/10 GbE SFP slots	Max PoE Ports	
	EHG7512-410GSFP	12-Port Managed Din-Rail Gigabit Switch with 4 x 1/10G SFP slots	-	8	-	4	-
	EHG7512-4PoE-410GSFP	12-Port Managed Din-Rail Gigabit Switch with 4 x 1/10G SFP slots and 4 PoE ports	-	8	-	4	4
	EHG7512-8PoE-410GSFP	12-Port Managed Din-Rail Gigabit Switch with 4 x 1/10G SFP slots and 8 PoE ports	-	8	-	4	8
	EHG7512-4SFP-410GSFP	12-Port Managed Din-Rail Gigabit Switch with 4 SFP and 4 x 1/10G slots	-	4	4	4	-
	EHG7512-4SFP-4PoE-410GSFP	12-Port Managed Din-Rail Gigabit Switch with 4 SFP slots, 4 PoE ports and 4 x 1/10G SFP slots	-	4	4	4	4
	EHG7516-410GSFP	16-Port Managed Din-Rail Gigabit Switch with 4 x 1/10G SFP slots	-	12	-	4	-
	EHG7516-4PoE-410GSFP	16-Port Managed Din-Rail Gigabit Switch with 4 x 1/10G SFP slots and 4 PoE ports	-	12	-	4	4
	EHG7516-8PoE-410GSFP	16-Port Managed Din-Rail Gigabit Switch with 4 x 1/10G SFP slots and 8 PoE ports	-	12	-	4	8
	EHG7516-4SFP-410GSFP	16-Port Managed Din-Rail Gigabit Switch with 4 SFP slots and 4 x 1/10G SFP uplinks	-	8	4	4	-
	EHG7516-4SFP-4PoE-410GSFP	16-Port Managed Din-Rail Gigabit Switch with 4 SFP, 4 PoE ports and 4 x 1/10G SFP uplinks	-	8	4	4	4
	EHG7516-4SFP-8PoE-410GSFP	16-Port Managed Din-Rail Gigabit Switch with 4 SFP, 8 PoE ports and 4 x 1/10G SFP uplinks	-	8	4	4	4
	EHG7516-8SFP-410GSFP	16-Port Managed Din-Rail Gigabit Switch with 8 SFP slots and 4 x 1/10G SFP uplinks	-	4	8	4	-
	EHG7516-8SFP-4PoE-410GSFP	16-Port Managed Din-Rail Gigabit Switch with 8 SFP, 4 PoE ports and 4 x 1/10G SFP uplinks	-	4	8	4	4
	EHG7516-12SFP-410GSFP	16-Port Managed Din-Rail Gigabit Switch with 12 SFP slots and 4 x 1/10G SFP uplinks	-	-	12	4	-
	EHG7520-410GSFP	20-Port Managed Din-Rail Gigabit Switch with 4 x 1/10G SFP slots	-	16	-	4	-
	EHG7520-4PoE-410GSFP	20-Port Managed Din-Rail Gigabit Switch with 4 x 1/10G SFP slots and 4 PoE ports	-	16	-	4	4
	EHG7520-8PoE-410GSFP	20-Port Managed Din-Rail Gigabit Switch with 4 x 1/10G SFP slots and 8 PoE ports	-	16	-	4	8
	EHG7520-4SFP-410GSFP	20-Port Managed Din-Rail Gigabit Switch with 4 SFP slots and 4 x 1/10G SFP uplinks	-	12	4	4	-
	EHG7520-4SFP-4PoE-410GSFP	20-Port Managed Din-Rail Gigabit Switch with 4 SFP, 4 PoE ports and 4 x 1/10G SFP uplinks	-	12	4	4	4
	EHG7520-4SFP-8PoE-410GSFP	20-Port Managed Din-Rail Gigabit Switch with 4 SFP, 8 PoE ports and 4 x 1/10G SFP uplinks	-	12	4	4	8
	EHG7520-8SFP-410GSFP	20-Port Managed Din-Rail Gigabit Switch with 8 SFP slots and 4 x 1/10G SFP uplinks	-	8	8	4	-
	EHG7520-12SFP-410GSFP	20-Port Managed Din-Rail Gigabit Switch with 12 SFP slots and 4 x 1/10G SFP uplinks	-	4	12	4	-
	EHG7520-12SFP-4PoE-410GSFP	20-Port Managed Din-Rail Gigabit Switch with 12 SFP, 4 PoE ports and 4 x 1/10G SFP uplinks	-	4	12	4	4
	EHG7520-16SFP-410GSFP	20-Port Managed Din-Rail Gigabit Switch with 16 SFP slots and 4 x 1/10G SFP uplinks	-	-	16	4	-

Layer-3 Managed Switches

ATOP's advanced Layer-3 (L3) managed Ethernet switches for harsh environments provide a rugged and solid solution for managing advanced networks that demand Routing between Different VLANs and IP-Based Routing.

Our L3 switches carry out real-time packet routing based on a local network's IP address, instead of the MAC address of the destination device. This series of switches supports:

- IPv4 Unicast Static Routing
- Dynamic Routing RIP (Routing Information Protocol) V1/V2
- OSPFv2 (Open Shortest Path First)
- VRRP (Virtual Router Redundancy Protocol)
- DVMRP (Distance Vector Multicast Routing Protocol)
- PIM-DM (Protocol Independent Multicast – Dense Mode)
- PIM-SM (Protocol Independent Multicast – Sparse Mode)
- PIM-SSM (Protocol Independent Multicast – Source-Specific Multicast)
- IGMPv1/v2/v3 & IGMP Snooping (Internet Group Management Protocol)
- DHCP Server

All models in this series are designed to meet the strictest Level 3 and Level 4 EMC compliance requirements. Our high-performance components guarantee real-time packet switching, even on full load. And they are available in Full-Gigabit versions with 4- to 20-port configurations, RJ45 or SFP connectors, and PoE support.

Layer-3 Managed DIN-Rail Switches

Industrial Layer-3 Managed Gigabit PoE Switches, DIN-Rail Mount















SKU	Description	10/100 RJ45 ports	10/100 /1000 RJ45 ports	1000 SFP slots	1/10 GbE SFP slots	Max PoE Ports
	EHG7604	4-Port Managed Gigabit Switch	-	4	-	-
	EHG7604-4PoE	4-Port Managed Gigabit Switch with 4 PoE ports	-	4	-	4
	EHG7604-2SFP	4-Port Managed Gigabit Switch with 2 SFP slots	-	2	2	-
	EHG7604-2PoE-2SFP	4-Port Managed Gigabit Switch with 2 SFP slots and 2 PoE ports	-	2	2	2
	EHG7604-4SFP	4-Port Managed Gigabit Switch with 4 SFP slots	-	-	4	-
	EHG7608	8-Port Managed Gigabit Switch	-	8	-	-
	EHG7608-4SFP	8-Port Managed Gigabit Switch with 4 SFP slots	-	4	4	-
	EHG7608-4PoE-4SFP	8-Port Managed Gigabit Switch with 4 SFP slots and 4 PoE ports	-	4	4	4
	EHG7608-8PoE	8-Port Managed Gigabit Switch with 8 PoE ports	-	8	-	-

Industrial Managed Layer-3 Gigabit PoE Switches, DIN-Rail mount

NEW
2018 Q2



SKU	Description	10/100 RJ45 ports	10/100 /1000 RJ45 ports	100/1000 SFP slots	1/10 GbE SFP slots	Max PoE Ports
	EHG7612-410GSFP	-	8	-	4	-
	EHG7612-4PoE-410GSFP	-	8	-	4	4
	EHG7612-8PoE-410GSFP	-	8	-	4	8
	EHG7612-4SFP-410GSFP	-	4	4	4	-
	EHG7612-4SFP-4PoE-410GSFP	-	4	4	4	4
	EHG7616-410GSFP	-	12	-	4	-
	EHG7616-4PoE-410GSFP	-	12	-	4	4
	EHG7616-8PoE-410GSFP	-	12	-	4	8
	EHG7616-4SFP-410GSFP	-	8	4	4	-
	EHG7616-4SFP-4PoE-410GSFP	-	8	4	4	4
	EHG7616-4SFP-8PoE-410GSFP	-	8	4	4	4
	EHG7616-8SFP-410GSFP	-	4	8	4	-
	EHG7616-8SFP-4PoE-410GSFP	-	4	8	4	4
	EHG7616-12SFP-410GSFP	-	-	12	4	-
	EHG7620-410GSFP	-	16	-	4	-
	EHG7620-4PoE-410GSFP	-	16	-	4	4
	EHG7620-8PoE-410GSFP	-	16	-	4	8
	EHG7620-4SFP-410GSFP	-	12	4	4	-
	EHG7620-4SFP-4PoE-410GSFP	-	12	4	4	4
	EHG7620-4SFP-8PoE-410GSFP	-	12	4	4	8
	EHG7620-8SFP-410GSFP	-	8	8	4	-
	EHG7620-12SFP-410GSFP	-	4	12	4	-
	EHG7620-12SFP-4PoE-410GSFP	-	4	12	4	4
	EHG7620-16SFP-410GSFP	-	-	16	4	-

Rack-mount Managed Switches

Flexibility

You can choose from among 6 different Layer-3 Routing Core versions (based on power supply and uplink port configurations) and five different 4- to 8-Port modules to customize your device in a very simple way.

Designed for PoE

RHG7X28 supports up to 24 Gigabit ports in any 4- or 8-port configuration. Specifically designed for bringing power through Ethernet cables to virtually anywhere, a maximum output Power over Ethernet of 720W over the 24 ports can be achieved (PoE/PoE+ configuration - 802.3af/at).

Available in **3 power input variants**, RHG7X28 is EN 61010-2-201-certified and designed to handle the harshest of environments. Its fanless design and EMC Level 3 protection guarantee operations in temperatures from -40°C to +75°C, and with 24 PoE ports running full power, it is sort the of device that can be trusted to work in your field or environment with minimum effort.

Power and versatility

Layer-3 versions support IPv4 and IPv6 Static Routing, RIPv1/v2, OSPFv2, IGMP, PIM Dense Mode and Sparse Mode, DVMRP and VRRP for Routing Redundancy. Through ERPS, RHG7X28 supports a network self-recovery time of under 20ms – even on full load. Most redundant ring topologies are supported: ITU-T G.8032 ERPS Ring, IEEE802.1D-2004 RSTP, STP, MSTP, MRP (Client), iA-Ring, iA-Chain and many other compatible rings.

Automation and IIoT

Being Profinet CC-B v2.33-certified and Ethernet/IP-ready makes the RHG7X28 Series the ideal backbone for your Industrial automation needs.

Secure

The first Industrial Managed Secure Switch! Protect your LAN from Eavesdropping and impersonation through 802.1AE MACsec. With no additional latency and 100% Gigabit Throughput guaranteed, dedicated modules provide you with the ultimate security solution (Layer-3 version only).

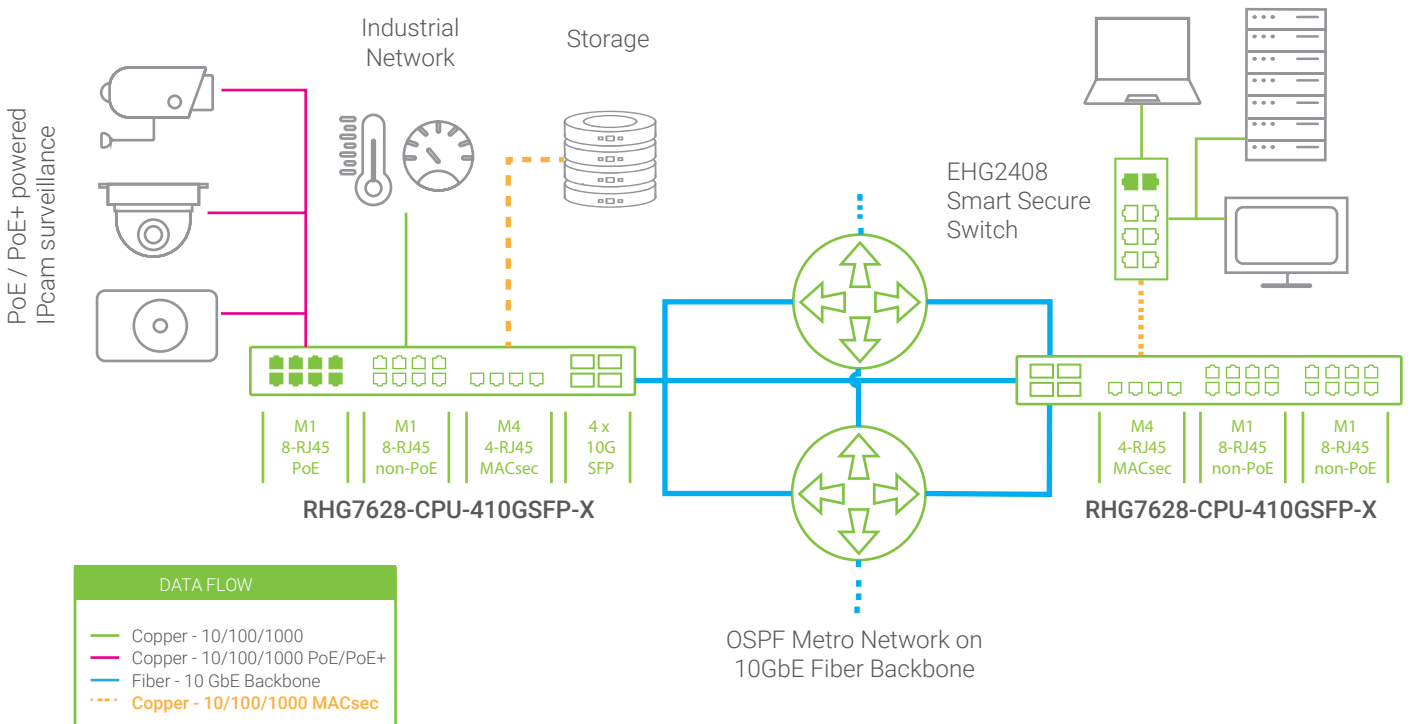

Modular Concept

A custom device can be built in a very simple way, by choosing from among five different hardware versions and five different 4- or 8-port hot-swappable modules. The corresponding software detects the connected module and enables the related set-up panels automatically, saving configuration and installation times.



RHG7628-CPU-410GSFP-R Main unit, with 4 x 10 Gigabit SFP uplink ports and redundant AC power input



RHG7X28-M1
8-port Gigabit RJ45 PoE module



RHG7X28-M2
8-port Gigabit RJ45 module



24 port L3 Managed Switch, with 8 Gigabit PoE, 8 Gigabit RJ45, 4 Gigabit SFP MACsec and 4 x 10 GbE uplink ports



Switch Core Platforms

ATOP's rack-mounted switches provide 4 different hardware versions, whether you need Layer-2 or Layer-3 Switching, and 4 x 10 Gigabit uplink ports.

For specific Layer-2 and Layer-3 features, please refer to their respective data-sheets.

Industrial Rack-Mount Gigabit Managed Switch

NEW

-40°C

75°C

PROFIBUS
NET

IEEE
1588

Ring

*

L3

Industrial
EMC

RACK

MILD-STD
810F

CFE

IP30
IEC60529

Layer	Uplink ports	Redundant power supply for CPU board (100~240 VAC)	Redundant power supply for CPU board (100~240 VAC)	Redundant DC 48~56V power supply
Layer 2*	4 x 1 GbE	RHG7528-CPU-4SFP-R	RHG7528-CPU-4SFP	RHG7528-CPU-4SFP-DC
	4 x 10 GbE	RHG7528-CPU-410GSFP-R	RHG7528-CPU-410GSFP	RHG7528-CPU-410GSFP-DC
Layer 3	4 x 1 GbE	RHG7628-CPU-4SFP-R	RHG7628-CPU-4SFP	RHG7628-CPU-4SFP-DC
	4 x 10 GbE	RHG7628-CPU-410GSFP-R	RHG7628-CPU-410GSFP	RHG7628-CPU-410GSFP-DC

* Layer 2 models do not support MACsec M4-M5 modules

Modules

Five different swappable modules are available for the RHG7X28 Series. Available in up to 74 combinations, the RHG7X28 Series allows you the flexibility you need for your specific application.

a. RHG7X28-M1- 8-Port RJ45 PoE module:

- i. 8 RJ45 10/100/1000 BaseT(X) ports
- ii. 30 W PoE Power per port (802.3af, 802.3at)
- iii. 240 W Maximum PoE power per module



b. RHG7X28-M2- 8-Port RJ45 module:

- i. 8 RJ45 10/100/1000 BaseT(X) ports



c. RHG7X28-M3- 8-Port SFP module:

- i. 8 SFP 100/1000 BaseF(X) slots
- ii. Speed software-selectable



d. RHG7X28-M4- 4-Port RJ45 MACsec module (*):

- i. 4 RJ45 10/100/1000 BaseT(X) ports
- ii. MACsec Hardware encryption on all ports



e. RHG7X28-M5- 4-Port SFP MACsec module (*):

- i. 4 SFP 100/1000 BaseF(X) slots
- ii. MACsec Hardware encryption on all ports



* Layer 2 models do not support MACsec M4-M5 modules.

Industry-specific Ethernet Switches

ATOP's range of industrial Ethernet switches are engineered for use in harsh environments, so you can develop cost-effective and secure networks without having to worry about implementation and reliability. With our extensive range of switches and knowledge of various protocol standards used in industries such as railway, transport, energy, and utilities, we can be sure to find a solution for your application – regardless of its environment and scale.

Industry Ethernet for Substation Automation and Smart Grids

Over the decades, various communication protocols have been developed to manage power grid networks and components such as RTUs and IEDs – and even control centers. The result has been different standards being adopted and used by numerous countries around the world. Distributed Network Protocol (DNP 3) has become the standard adopted in North America. Europe has relied mainly on IEC 60870-5 101/103/104, with much of the world using Modbus protocol, due to its openness and ease.

To simplify all of this, IEC 61850 was developed to provide a standard communication protocol for electrical substations and power grid automation. Specializing its domain knowledge in electrical power grid systems, IEC 61850 is an object-oriented protocol that uses a data modeling scheme to clearly describe each component of a power grid or substation as standard logical nodes – such as object processes, protection, control, and functionality.

This specialization enables data access to the power grid system to yield more details. And to further improve reliability and performance, **IEC 61850 Part 3 also specifies the hardware and network suitability requirements** – such as electro-magnetic immunity (EMI), surge protection, vibration and shock resistance, and the temperature range in which devices must be able to function. **ATOP's switches comply with these specifications.**

IEC 61850-3 Device Compliancy Specifications

- Operate in a temperature range of -40°C to 85°C.
- Be capable of reliably handling long distance transmissions through Fiber optic connectivity.
- Guarantee QoS (Quality of Service) management and real-time packet switching for GOOSE event messages.
- Guarantee a level of redundancy that minimizes packet loss. Ring topologies should be supported, and zero-packet-loss technologies such as HSR (High availability Seamlessly Redundancy) or PRP (Parallel Redundancy Protocol) are strongly recommended to be supported. ATOP's devices support RSTP (Rapid Spanning-Tree Protocol) and ERPS rings. When equipped with HSR/PRP modules, our Innovative RHG9528 switch can guarantee against loss of GOOSE packets.
- Have a wide tolerance for vibrations and shocks. ATOP's MIL-STD-810F device fully complies.
- Have tough electromagnetic immunity and comply with emission standards, as PoE is not allowed in IEC 61850-3.
- Have at least Level 3 EMC protection; have at least Level 4 ESD, EFT and Surge protection; and have at least Level 5 PFMF and Damped Oscillatory Magnetic Field immunity.





Test	Version	Item		Value	Level	Criterion
IEC 61000-4-2	2008	ESD	Contact Discharge AirDischarge	±8KV ±15KV	4 4	B B
IEC 61000-4-3	2010	RS	Enclosure Port	10(V/m), 80-1000MHZ, 80% AM, 1G~3GHZ	3	A
IEC 61000-4-4	2012	EFT	AC Power Port DC Power Port Signal Port	±4.0KV@ 2.5KHz ±4.0KV@ 2.5KHz ±2.0KV@ 5.0KHz	4 4 4	B B B
IEC 61000-4-5	2014	Surge	AC Power Port AC Power Port DC Power Port DC Power Port Signal Port	Line-to Line±2.0KV Line-to Earth±4.0KV Line-to Line±1.0KV Line-to Earth±2.0KV Line-to Earth±4.0KV	4 4 3 3 4	B B B B B
IEC 61000-4-6	2013	CS	AC Power Port DC Power Port Signal Port	10V, 150KHz~80MHZ, 80%AM 10V, 150KHz~80MHZ, 80%AM 10V, 150KHz~80MHZ,80%AM	3 3 3	A A A
IEC 61000-4-8	2009	PfMF	(Enclosure)	100A/m continuous,1000A/m for 3S	5	A
IEC61000-4-10	2000	Damped Oscillatory magnetic Field	(Enclosure)	100A/m,100KHz,1MHz	5	A
IEC 61000-4-11	2004	DIP	AC Power Port	Drop 70% for 3 times/S (1 Period) Drop 40% for 3 times/1mS (50 Period) Drop 100% for 3 times/50mS (5 & 50 Period)	N/A N/A N/A	A A A
IEC 61000-4-12	2006	Damped Oscillatory	AC Power Port Signal Port	2.5KV common,1KV differential mode @ 1MHz 2.5KV common,1KV differential mode @ 1MHz	3 3	B B

IEC 61850-3 DIN-Rail Managed Gigabit Switches

IEC 61850-3 Certified Managed Gigabit Switches, DIN-Rail mount



SKU	Description	10/100 / 1000 RJ45 ports	1000 SFP slots	Total Ports	Power Input	
	EHG9508-2SFP	8-Port IEC 61850-3 certified Managed Gigabit Switch, with 2 Gigabit SFP slots,	6	2	8	Dual 24~57 VDC input
	EHG9508-2SFP-HV	8-Port IEC 61850-3 certified Managed Gigabit Switch, with 2 Gigabit SFP slots, High Voltage	6	2	8	Dual 110~370 VDC input
	EHG9508-2SFP-AC	8-Port IEC 61850-3 certified Managed Gigabit Switch, with 2 Gigabit SFP slots, AC input	6	2	8	Dual 100~240 VAC input
	EHG9512-4SFP	12-Port IEC 61850-3 certified Managed Gigabit Switch, with 8 Gigabit SFP slots	8	4	12	Dual 24~57 VDC input
	EHG9512-4SFP- HV	12-Port IEC 61850-3 certified Managed Gigabit Switch, with 8 Gigabit SFP slots, High Voltage	8	4	12	Dual 110~370 VDC input
	EHG9512-4SFP- AC	12-Port IEC 61850-3 certified Managed Gigabit Switch, with 8 Gigabit SFP slots, AC input	8	4	12	Dual 100~240 VAC input

IEC 61850-3 Rack-Mount Managed Gigabit Switch

RHG9528 is a modular, rack-mounted, and IEC61850-3-certified Managed Switch that is ideal for substation automation, with its modular architecture allowing you to tailor the device to your specific applications.

The CPU board can be chosen based on the features and the power supply input you need. All core models are all equipped with 4 x 10 Gigabit Ethernet uplink SFP slots, redundant power input and 3 freely utilizable module slots.



Conceived for Telecom and Power applications, the modular architecture of RHG9528 allows it to be deployed simply as either a managed switch, a PTP Transparent clock, a PTP Boundary clock, a SyncE clock, or as a High-Availability IEC62439-3 HSR and IEC62439-4 PRP device.

Its rugged design, wide temperature range and high EMC protection, combined with IEC61850-3 and IEEE1613 certifications for the Power Sector, make the RHG9528 Series the ideal solution for a IEC61850 substation use.

Features

- **RHG9528-CPU:** 3 module slots; up to 24 x Gigabit ports; 4 x 1/10GbE SFP uplink slots.
- **RHG9528-CPU-BC:** 3 module slots; up to 24 x Gigabit ports; 4 x 1/10GbE SFP uplink slots; hardware Boundary clock.
- **RHG9528-CPU-BC-SE:** 3 module slots; up to 24 x Gigabit ports; 4 x 1/10GbE SFP uplink slots; hardware Boundary clock and Synchronous Ethernet support for Telecom (ITU-T G.8261).

High Availability for zero packet loss (HSR/PRP)

When equipped with High-Availability HSR/PRP modules, the RHG9528 series complies with the most stringent redundancy requirements, ensuring zero packet loss and that GOOSE packets arrive at their intended destination. Otherwise, it also provides a network redundant self-recovery time of under 20ms, even on full load, which enables a reliable network to be built with almost any redundant ring topology using traditional redundancy protocols. RHG9528 supports: ITU-T G.8032 ERPS Ring; IEEE802.1D-2004 RSTP; STP; MSTP; MRP (Client); iA-Ring; iA-Chain; and many other compatible rings protocols for network redundancy. And with a Multifunctional web dashboard, it offers intelligent features such as Quality of service (QoS), IGMP, and Port mirroring.

IEEE1588v2 Precision Time Protocol TC and BC features

In Telecom applications, there can be tens of thousands or hundreds of thousands of cells that need to be collectively synchronized, which can often lead to bottlenecks on both the CPU load of the Grandmaster Clock (GMC) and on the physical links that are too close to the GMC.

In Telecom applications, but also in Power applications, Boundary Clocks are very commonly used to combat this. A Boundary Clock device is usually embedded inside a Layer-2 or Layer-3 Switch. It acts as a Slave to a GMC and as a Master to all the slaves that are downstream. By setting up this intermediate layer, the GMC has to take care of the synchronization of Boundary Clocks only, and Boundary Clocks will either sync the slaves themselves or with other Boundary clocks, and so on.

A good Boundary Clock, like the Grandmaster Clock, must have hardware-generated Timestamps to be highly accurate, and should be equipped with an internal good Oscillator (usually OCXOs are used) to limit time-drift – in case the Grandmaster Clock should unexpectedly fail or a network link upstream has an issue. Such embedded high-quality oscillators prevent a daily drift of more than 36 µs.

Power Supply Options

- No suffix: 18~135 VDC redundant power input
- AC version: 100~240 VAC redundant power input
- HV version: 185-435 VDC redundant power input

IEC 61850-3 Certified Managed Gigabit Switches, Rack-mount

NEW
2018 Q2



SKU	Description	1/10G SFP Uplinks	Slots	Additional features	
	RHG9528-CPU-410GSFP	Modular IEC61850-3 Managed Switch Core, 3 modules, DC	4	3	18~135VDC power input
	RHG9528-CPU-410GSFP-AC	Modular IEC61850-3 Managed Switch Core, 3 modules, AC	4	3	100~240VAC power input
	RHG9528-CPU-410GSFP-HV	Modular IEC61850-3 Managed Switch Core, 3 modules, High-voltage DC	4	3	185~435VDC power input
	RHG9528-CPU-BC-410GSFP	Modular IEC61850-3 Managed Switch Core with Boundary clock, 3 m., DC	4	3	Hardware-boundary clock 18~135VDC power input
	RHG9528-CPU-BC-410GSFP-AC	Modular IEC61850-3 Managed Switch Core with Boundary clock, 3 m., AC	4	3	Hardware-boundary clock 100~240VAC power input
	RHG9528-CPU-BC-410GSFP-HV	Modular IEC61850-3 Managed Switch Core with Boundary clock, 3 m., HV DC	4	3	Hardware-boundary clock 185~435VDC power input
	RHG9528-CPU-BC-SE-410GSFP	Modular IEC61850-3 Managed Switch Boundary clock core, SyncE, 3m., DC	4	3	HW BC and SyncE 18~135VDC power input
	RHG9528-CPU-BC-SE-410GSFP-AC	Modular IEC61850-3 Managed Switch Boundary clock core, SyncE, 3m., AC	4	3	HW BC and SyncE 100~240VAC power input
	RHG9528-CPU-BC-SE-410GSFP-HV	Modular IEC61850-3 Managed Switch Boundary clock core, SyncE, 3m., HV DC	4	3	HW BC and SyncE 185~435VDC power input

Modules

SKU	Description	10/100 /1000 RJ45	100 /1000 SFP	Additional features	
	RHG9528-M1	8-Port Gigabit RJ45 Module	8	-	
	RHG9528-M2	8-Port Gigabit SFP Module	-	8	
	RHG9528-M3	4-port Gigabit RJ45 HSR/PRP module, working as HSR/PRP/Quadbox/etc..	4	-	HSR/PRP/Redbox/Quadbox
	RHG9528-M4	4-port Gigabit SFP HSR/PRP module, working as HSR/PRP/Quadbox/etc..	-	4	HSR/PRP/Redbox/Quadbox

Railway Networking: EN50155 and EN50121-4

EN 50155 is widely recognized as the standard in Europe for electronic equipment in railway applications, defining the criteria that network devices must comply with – such as wide temperature ranges; humidity, shock, and vibration resistance; power supplies, electromagnetic interference, power surges, electrostatic discharges (ESD) and transient factors.

EN50121-4 instead, even though being part of EN50155, defines the requirements of Trackside Equipment used -for example- for Signaling.

Complying with the essential sections of EN50155 and EN50121-4 for ground equipment, ATOP's railway-certified switches are powerful industrial ethernet switches with advanced features that are encased in robust and reliable housing, making them highly suitable for use in signal control networks. Selected products are NEMA TS-2-certified, allowing them to be used in the most demanding of traffic control applications.



Mechanical requirements

• Rolling equipment:

- Vibration: Category < 0.3 Kg
- Frequency range : 5 – 150 Hz
- Acceleration: 5G
- Shock (half sinus): Long/ Trans. /Vert Axis
- Peak acceleration: 5g/2g/1g
- Duration: 50 ms / 20 ms / 20 ms

• Ground equipment: N/A

Temperature Requirements

Category	Internal cabinet temperature range	Ambient board temperature range	GAIA converter modules temperature range
T1	-25/55 °C	-25/70 °C	Industrial line: -40/71 °C ambient
T2	-40/55 °C	-40/70 °C	Industrial line: -40/71 °C ambient
T3	-25/70 °C	-25/85 °C	Hi-rel line: -40/85 °C ambient
T4	-40/70 °C	-40/85 °C	Hi-rel line: -40/85 °C ambient

Humidity: EN50155 2 x 25H 40

Electromagnetic compatibility:

- CE/FCC
- 24 VDC: 500 Veff/ 50 Hz/ 1 min
- 48 VDC: 500 Veff/ 50 Hz/ 1 min
- 72~125 VDC : 1,000 Veff/ 50 Hz/ 1 min
- 125~315 V: 1,500 Veff/ 50 Hz/ 1 min
- For other details rely to EN50155

...our Application Example

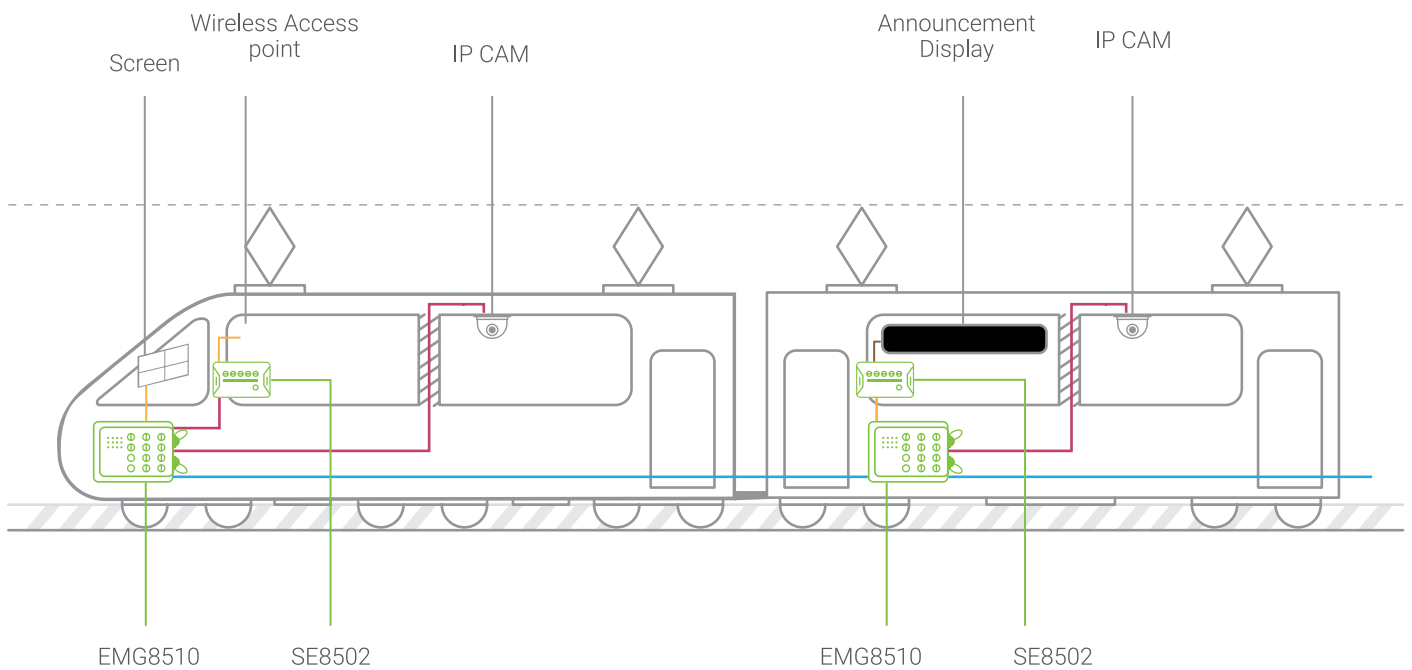
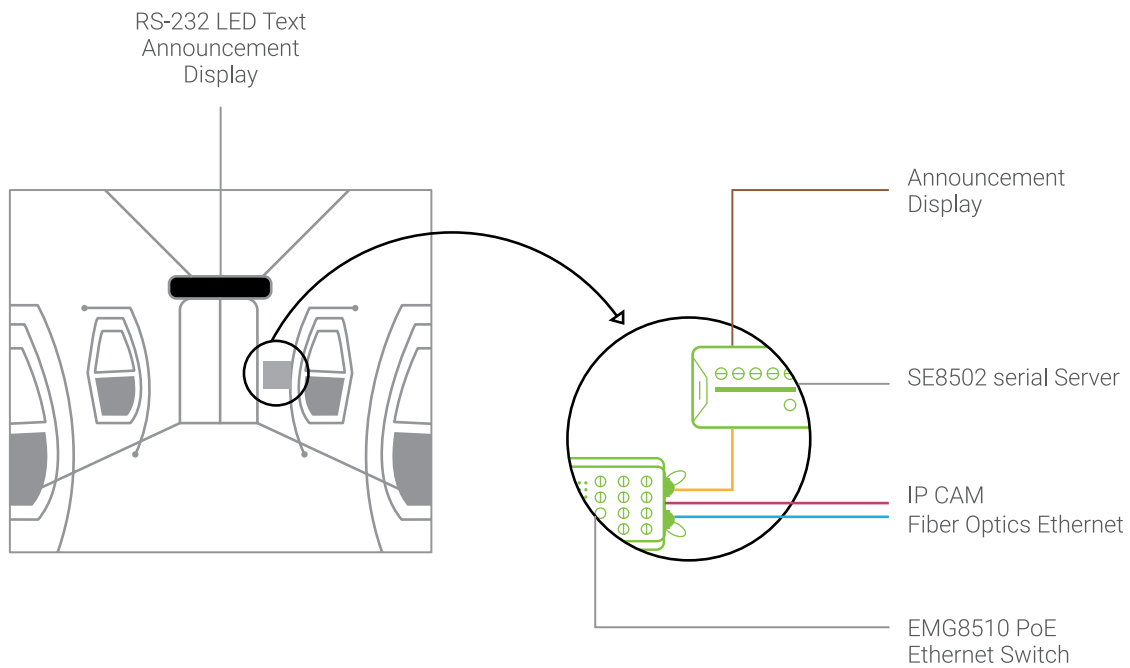

PROTOCOLS

- Fiber Optics Ethernet
- Twist Pair Ethernet
- PoE
- RS-232 Serial

...more information on our Application Example



EMG8305 - EN50155 Railway-certified IP67 Gigabit Unmanaged switch

- 5 x 10/100/1000 ports with M12 connectors
- EN50155, EN50121-4, UL/IEC(CB) 61010-2-201 certified
- Redundant Power Input; M12 A-coding or X-coding available
- -40~75 °C operational temperature, IP67 Aluminum Housing, MIL-STD ready
- Profinet Packet Prioritization according to 802.1p



EMG8510 - EN50155 Railway-certified IP67 Gigabit Managed PoE Switch with SFP backbone

- 8 x 10/100/1000 ports with M12 connectors and 2 Gigabit SFP slots
- Max 8 x 30 W 802.3af- 802.3at Power over Ethernet ports (240W power budget)
- EN50155, EN50121-4, UL/IEC(CB) 61010-2-201 certified
- Redundancy through ERPS/RSTP/MRP (client)
- Hw-assisted IEEE 1588v2 Precision Time Protocol End-to-End Transparent Clock
- -40~75 °C operational temperature, IP67 Aluminum Housing, MIL-STD ready
- Profinet CC-B compatible



SE8502 - EN50155 Railway-certified IP68 Serial Device Server

- 1 Fast Ethernet port with M12 connectors
- 2 isolated RS-232 RS-485 RS-422 serial ports with M12 connector
- EN50155, EN50121-4 certified
- 15 kV serial port isolation, VirtualCOM.
- -40~75 °C operational temperature, IP68 Housing

EN50155 Railway Unmanaged Switches

Unmanaged Fast-Ethernet Switches, Gigabit Uplink, DIN-Rail Mount



SKU	Description	10/100 RJ45 ports	10/100 / 1000 RJ45	1000 SFP slots	100 Fiber Ports	1000 Fiber Ports
	EH7310-G	10-Port Unmanaged Ethernet Switch with 2 Gigabit RJ45 uplink ports	8	2	-	-
	EH7310-G-2Fm	10-Port Unmanaged Ethernet Switch with 2 Gigabit Multi-mode Fiber Optic Uplinks	8	-	-	2 (m)
	EH7310-G-2Fs	10-Port Unmanaged Ethernet Switch with 2 Gigabit Single-mode Fiber Optic Uplinks	8	-	-	2 (s)
	EH7310-2Fm	10-Port Unmanaged Ethernet Switch with 2 Multi-mode Fiber Optic Uplinks	8	-	-	2 (m)
	EH7310-2Fs	10-Port Unmanaged Ethernet Switch with 2 Single-mode Fiber Optic Uplinks	8	-	-	2 (s)

Unmanaged Waterproof Gigabit Switches, Field Mount, Aluminum Housing

NEW





SKU	Description	10/100 M12 ports	10/100 / 1000 M12 ports	M12 Type	Additional features	
	EMG8305-M12-A	5-Port IP67 Unmanaged Gigabit Switch with M12 connectors, A-coding	-	5	A coding	Profinet packet prioritization
	EMG8305-M12-X	5-Port IP67 Unmanaged Gigabit Switch with M12 connectors, X-coding	-	5	X coding	Profinet packet prioritization

EN50155 Managed Switches

Managed Waterproof Gigabit Switches, Field-Mount, Aluminum Housing

NEW



SKU	Description	10/100 M12 ports	10/100 / 1000 M12 ports	1000 SFP slots	Max PoE Ports
	EMG8508	8-Port IP67 Managed Gigabit Switch	8	-	-
	EMG8508-4PoE	8-Port IP67 Managed Gigabit Switch with 4 PoE ports	8	-	4
	EMG8508-8PoE	8-Port IP67 Managed Gigabit Switch with 8 PoE ports	8	-	8
	EMG8508-HV	8-Port IP67 Managed Gigabit Switch, 50~145 VDC power input	8	-	-
	EMG8510-2SFP	10-Port IP67 Managed Gigabit Switch, with 2 Gigabit SFP ports	8	2	-
	EMG8510-4PoE-2SFP	10-Port IP67 Managed Gigabit Switch, with 2 Gigabit SFP ports and 4 PoE ports	8	2	4
	EMG8510-8PoE-2SFP	10-Port IP67 Managed Gigabit Switch, with 2 Gigabit SFP ports and 8 PoE ports	8	2	8
	EMG8510-2SFP-HV	10-Port IP67 Managed Gigabit Switch, with 2 Gigabit SFP ports, 50~145 VDC power input	8	2	-

Industrial Wireless

ATOP's Industrial Wireless Access Points (AP) provide reliable, robust, rugged, and cost-effective solutions for Industrial applications that require wireless connectivity.

ATOP's APs are equipped with a powerful 2 x 2 MIMO Radio interface that supports IEEE 802.11 a/b/g/n, 2.4 GHz and 5 GHz selectable bands. They can run in multiple modes, such as Access Point (AP) mode, Wireless Distribution Bridge (WDS) mode or Access Point (AP) Client Operation mode.

The devices are designed to be fully operational between -20°C and +60 °C, and they also feature built-in DIN-Rail mounts.



Industrial Wireless Access Point, IEEE 802.11 a/b/g/n, DIN-Rail Metal Housing



SKU	Description	10/100 /1000 RJ45 ports	10/100 SFP ports	Fiber ports	Additional features
 AW5500	IEEE 802.11 a/b/g/n Access Point/ Bridge/Client	1	-	-	

Industrial Wireless Access Point, IEEE 802.11 b/g/n, DIN-Rail Metal Housing



SKU	Description	10/100 RJ45 ports	10/100 SFP ports	Fiber ports	Additional features
 AW5500C	IEEE 802.11 b/g/n Access Point/ Bridge/Client Supporting WiFi direct	1	-	-	WPS button

Media Converters



From entry-level to advanced smart versions, ATOP's media converters are ideal for transitioning from copper-based to fiber-based networks.

All products in this series are suitable for operational temperatures from -20°C to +70°C. Selected versions can operate in temperatures between -40°C and +70°C. And they come with redundant power supplies and automatic speed negotiation.



Industrial Smart Ethernet to Fiber converter, Auto Speed Negotiation, DIN-Rail



SKU	Description	10/100 RJ45 ports	10/100 /1000 RJ45 ports	Auto Negotiation SFP slots	Fiber ports	Rated distance	
	EF23-1-1Fm-SC-2	Fast Ethernet to Fiber converter, SC connector, multi-mode, 2km	1		1 (multi-mode)	2 km	
	EF23-1-1Fs-SC-30	Fast Ethernet to Fiber converter, SC connector, single-mode, 30km	1		1 (single-mode)	30 km	
	EF24-1G-1Fm-SC-550M	Gigabit Ethernet to Fiber converter, SC connector, multi-mode, 550m	-	1	-	1 (multi-mode)	550 m
	EF24-1G-2Fm-SC-550M	Gigabit Ethernet to Fiber converter and repeater, SC connector, multi-mode, 550m	-	1	-	2 (multi-mode)	550 m
	EF24-1G-1Fs-SC-10K	Gigabit Ethernet to Fiber converter, SC connector, single-mode, 10 km	-	1	-	1 (single-mode)	10 Km
	EF24-1G-2Fs-SC-10K	Gigabit Ethernet to Fiber converter and repeater, SC connector, single-mode, 10 km	-	1	-	2 (single-mode)	10 Km
	EF24-1G-1Fs-SC-20K	Gigabit Ethernet to Fiber converter, SC connector, single-mode, 20 km	-	1	-	1 (single-mode)	20 Km
	EF24-1G-1SFP	Gigabit Ethernet to Fiber converter, SFP slot	-	1	1	1 (SFP slot)	n/a
	EF24-1G-2SFP	Gigabit Ethernet to Fiber converter and repeater, SFP slot	-	1	2	2 (SFP slot)	n/a

Serial to Fiber Media Converters, DIN-Rail mount, Metal Housing



SKU	Description	RS-232 RS-485 RS-422 TB5	Fiber ports	Rated distance
	SF63-TB-DB-1Fm-SC	1	1 (multi-mode)	2 Km
	SF63-TB-DB-1Fs-SC	1	1 (single-mode)	30 Km
	SF63-TB-DB-1Fm-ST	1	1 (multi-mode)	2 Km
	SF63-TB-DB-1Fs-ST	1	1 (single-mode)	30 Km

Serial Device Servers

Introduction

ATOP's Serial to Ethernet Device Servers allows easy connection between RS-232/422/485 legacy devices to Ethernet through both wireless or wired connectivity. These devices are specifically designed to allow industrial devices to be directly accessible from the local network or the Internet.

Our devices either in entry-level or industrial grade support 1 - 16 serial and are available in field-mount, DIN-rail mount, and rack-mount, making it a very powerful platform for legacy devices integration with modern network infrastructures. With ATOP's Management Utility software, you will also be able to enable VirtualCom on the computer seamlessly using Ethernet or via any serial device you want.



Use them as Embedded Computers!

ATOP's Serial Device Servers versions provide programmability with SDKs on Linux-based platforms. Using the supplied Programming guide, it is easy to develop applications for specific applications.

Ask your sales representative for more information or consult our ATOP SDK Products brochure.

Entry level Serial Device Servers

ATOP's Entry-level Serial Device Servers provide 1- or 2-port RS-232/RS-422/RS-485 connectivity, and are suitable for simple and less demanding applications. These Serial Device Servers are available with a DB9 or TB5 connector with 2kV magnetic isolation. Selected versions are Industrial-EMC certified.

Entry Level Serial Device Server, Field Mount, Metal Housing



SKU	Description	RS-232 RS-485 RS-422 TB5	RS-232 RS-485 RS-422 DB9	10/100 RJ45 Ports	Additional features
	SE5001	-	1	1	
	SE5002(DB)	-	1	1	
	SE5002-S5Sis(TB)	1	-	1	2kV Magnetic Isolation

Industrial EMC Serial Server, Field Mount, Metal Housing



SKU	Description	RS-232 RS-485 RS-422 TB5	RS-232 RS-485 RS-422 DB9	10/100 RJ45 Ports	10/100 Fiber ports	100 SFP slots
	SE5001A	-	1	1		
	SE5001A-TB	1	-	1		
	SE5002D	-	2	1	-	-
	SE5002D-TB	2	-	1	-	-
	SE5002D-Fm	-	2	-	1 (multi)	-
	SE5002D-Fs	-	2	-	1 (single)	-
	SE5002D-TB-Fm	2	-	-	1 (multi)	-
	SE5002D-TB-Fs	2	-	-	1 (single)	-
	SE5002D-SFP	-	2	-	-	1
	SE5002D-TB-SFP	2	-	-	-	1

Wireless / Cellular Serial Device Servers

Where cabling installation is an issue, ATOP's wireless serial servers provide a reliable and affordable solution for Serial and Ethernet conversion, with one or two available ports and terminal block or DB9 connector. Selected versions feature Industrial EMC compatibility, MIMO dual-antenna features and IEEE 802.11 a/b/g/n and 3G/4G/HSPA connectivity.

Industrial Wireless IEEE 802.11 b/g/n Serial Device Server, DIN-Rail



SKU	Description	RS-232 RS-485 RS-422 TB5	RS-232 RS-485 RS- 422 DB9	10/100 RJ45 Ports	Additional features
	SW5501C	(1)	(1)	1	WPS button
	SW5502C-TB	-	2	1	WPS button
	SW5502C	2	-	1	WPS button

Industrial Wireless IEEE 802.11 a/b/g/n Serial Device Server, Industrial EMC



SKU	Description	RS-232 RS-485 RS-422 TB5	RS-232 RS-485 RS- 422 DB9	10/100 1000 RJ45 Ports	Additional features
	SW5501	-	1	1	
	SW5501-TB	1	-	1	
	SW5501-Sis	1	-	1	2 kV isolation
	SW5502	-	2	1	
	SW5502-TB	2	-	1	
	SW5502-Sis	2	-	1	2 kV isolation

Industrial Cellular 3/4G Serial Device Servers, Digital I/O, DIN-Rail mount

NEW



SKU	2G/3G/HSPA	4G	RS-232 RS-485 TB14	RS-232 RS-485 DB9	10/100/1000 RJ45 Ports	Digital Inputs/ Digital Outputs	Additional features
 SE5901B-D3G	X		-	1	1	-	
SE5901B-IO-D3G	X		1+1*	-	1	2/2	
SE5901B-IO-D3G-GPS	X		1+1*	-	1	2/2	GPS
SE5901B-4G	X		-	1	1	-	
SE5901B-IO-4G	X	X	1+1*	-	1	2/2	
SE5901B-IO-4G-GPS	X	X	1+1*	-	1	2/2	GPS
SE5901B-4G-B	X	X	-	1	1	-	Battery function
SE5901B-IO-4G-B	X	X	1+1*	-	1	2/2	Battery function
SE5901B-IO-4G-GPS-B	X		1+1*	-	1	2/2	GPS / Battery function

* one TB14 sw-selectable RS-485; RS-232 and one RS-232.

Advanced Serial Device Servers

ATOP's advanced serial device servers feature a wider operational temperature range – from -20°C to +70°C, with selected versions featuring a range of -40°C to +85°C. In addition, they feature advanced EMC capabilities and faster CPUs to provide advanced features and faster processing times. They are more suitable for challenging environments. Selected advanced units provide additional gigabit connectivity and Power over Ethernet (PoE), so that ordinary power supplies don't need to be relied on.

Advanced Industrial Serial Device Servers, DIN-Rail Mount



SKU	Description	RS232- RS485- RS422 TB5	RS-232 RS-485 RS-422 DB9	10/100 RJ45 Ports	Additional features
 SE5901-DB	Industrial 2-Ethernet 1- Serial Device Server (DB)	-	1	2	
SE5901-TB	Industrial 2-Ethernet 1- Serial Device Server (TB)	1	-	2	
SE5901-DB-PoE	Industrial 2-Ethernet 1- Serial Device Server (DB), can be PoE Powered	-	1	2	PoE powered
SE5901-TB-PoE	Industrial 2-Ethernet 1- Serial Device Server (TB), can be PoE Powered	1	-	2	PoE powered

Advanced Industrial Serial Device Servers, DIN-Rail Mount

NEW

-40°C 85°C

Industrial EMC

DIN

IP30 IEC60529

SKU	Description	RS-232 RS-485 RS-422 TB5	RS-232 RS-485 RS-422 DB9	10/100 RJ45 Ports	1000 Gigabit	Additional features
	SE5904D-DB	Industrial 2-Ethernet - 4-Serial device Server (DB)	4	2	-	
	SE5904D-TB	Industrial 2-Ethernet - 4-Serial device Server (TB)	4	2	-	
	SE5904D-SIS	Industrial 2-Ethernet - 4-Serial device Server (TB), with 3kV Serial Isolation	4	2	-	3kV isolation
	SE5904D-DB-PoE	Industrial 2-Ethernet - 4-Serial device Server (DB), PoE	4	2	-	PoE-powered
	SE5904D-TB-PoE	Industrial 2-Ethernet - 4-Serial device Server (TB), PoE powered	4	2	-	PoE-powered
	SE5904D-Sis-PoE	Industrial 2-Ethernet - 4-Serial device Server with Isolation, PoE powered	4	2	-	PoE-powered, 3kV isolation
	SE5904D-G-DB-SFP	Industrial 2-Ethernet - 4-Serial device Server (DB), Gigabit SFP slot	4	2	-	
	SE5904D-G-TB-SFP	Industrial 2-Ethernet - 4-Serial device Server (TB), Gigabit SFP slot	4	2	-	
	SE5904D-G-Sis-SFP	Industrial 2-Eth 4-Serial device Server with Isolation, Gigabit SFP	4	2	-	3 kV isolation

Advanced Serial Device Servers, Rack-Mount

NEW

-20°C 70°C

RACK

Industrial EMC

IP30 IEC60529

SKU	Description	RS-232 RS-485 RS-422 RJ45	RS-232 RJ45	10/100 RJ45 Ports	Additional features
	SE5908-N-DC	Industrial 8-Port Serial Device Server with RJ45 serial, RS-232/422/485, 24-48 VDC power input	8	2	
	SE5908-SIS-DC	Industrial 8-Port Serial Device Server with RJ45 serial, RS-232, 24-48 VDC input, 2.5kV serial isolation	8	2	2.5 kV isolation
	SE5916-N-DC	Industrial 16-Port Serial Device Server with RJ45 serial, RS-232/422/485, 24-48 VDC power input	16	2	
	SE5916-SIS-DC	Industrial 16-Port Serial Device Server with RJ45 serial, RS-232, 24-48 VDC input, 2.5kV serial isolation	16	2	2.5 kV isolation
	SE5908-N-EU	Industrial 8-Port Serial Device Server with RJ45 serial, RS-232/422/485, 100~240 VAC power input, EU plug	8	2	
	SE5908-N-US	Industrial 8-Port Serial Device Server with RJ45 serial, RS-232/422/485, 100~240 VAC power input, US plug	8	2	
	SE5916-N-EU	Industrial 16-Port Serial Device Server with RJ45 serial, RS-232/422/485, 100~240 VAC power input, EU plug	16	2	
	SE5916-N-US	Industrial 16-Port Serial Device Server with RJ45 serial, RS-232/422/485, 100~240 VAC power input, US plug	16	2	
	SE5908-SIS-EU	Industrial 2-Ethernet 8-Serial Device Server with RJ45 connectors, RS-232, 2.5 kV isolation, 100~240VAC, EU plug	8	2	2.5 kV isolation
	SE5908-SIS-US	Industrial 2-Ethernet 8-Serial Device Server with RJ45 connectors, RS-232, 2.5 kV isolation, 100~240VAC, US plug	8	2	2.5 kV isolation
	SE5916-SIS-EU	Industrial 2-Ethernet 16-Serial Device Server with RJ45 connectors, RS-232, 2.5 kV isolation, 100~240VAC, EU plug	16	2	2.5 kV isolation
	SE5916-SIS-US	Industrial 2-Ethernet 16-Serial Device Server with RJ45 connectors, RS-232, 2.5 kV isolation, 100~240VAC, US plug	16	2	2.5 kV isolation

IEC61850-3 – Substation-specific Serial Device Servers

ATOP's Substation serial servers feature: 8 to 16 x Serial ports (RS-232/RS-485/RS-422) with or without isolation; 6 x Ethernet ports with RJ45 or SFP connector; and are enclosed in a rugged IP30-rated rack-mount housing. Available in two different power options: redundant 24–48VDC input or redundant 100–330VDC / 100–240VAC.2, with additional relay outputs are available.

IEC61850-3 Certified Substation Serial Device Server

NEW -40°C 85°C

SKU	Description	RS-232 RS-485 RS-422 TB5	RS-232 RS-485 RS-422 DB9	10/100 RJ45 Ports	100 Mbps SFP Slots	Additional features
 SE5908A **	Industrial IEC61850-3 8-Port Serial Device Server, DB9(M), RS-232/422/485, RJ45	-	8	6	-	
SE5908A-TB **	Industrial IEC61850-3 8-Port Serial Device Server, TB5, RS-232/422/485, RJ45	8	-	6	-	
SE5908A-SIS **	Industrial IEC61850-3 8-Port Serial Device Server, TB5, RS-422/485, RJ45, 3kV Isolation	8 *	-	6	-	3kV isolation
SE5908A-6SFP **	Industrial 2-Ethernet - 4-Serial device Server (TB)	-	8	-	6	
SE5908A-6SFP-TB **	Industrial 2-Ethernet - 4-Serial device Server (TB), with 3kV Serial Isolation	8	-	-	6	
SE5908A-6SFP-SIS **	Industrial 2-Ethernet - 4-Serial device Server (DB), PoE	8 *	-	-	6	3kV isolation
SE5916A **	Industrial IEC61850-3 16-Port Serial Device Server, DB9(M), RS-232/422/485, RJ45	-	16	6	-	
SE5916A-TB **	Industrial IEC61850-3 16-Port Serial Device Server, DB9(M), RS-232/422/485, RJ45	16	-	6	-	
SE5916A-SIS **	Industrial IEC61850-3 16-Port Serial Device Server, DB9(M), RS-232/422/485, RJ45	16 *	-	6	-	3kV isolation
SE5916A-6SFP **	Industrial 2-Ethernet - 4-Serial device Server (TB)	-	16	-	6	
SE5916A-6SFP-TB **	Industrial 2-Ethernet - 4-Serial device Server (TB), with 3kV Serial Isolation	16	-	-	6	
SE5916A-6SFP-SIS **	Industrial 2-Ethernet - 4-Serial device Server (TB), with 3kV Serial Isolation	16 *	-	-	6	3kV isolation

* The SiS (3kV isolated) version supports 8 or 16 RS-422/ RS-485
 ** All versions are available in 24~48VDC or 100~370VDC/100~240VAC power input (add -HV to model name)

EN50155 – Railway specific Serial Device Servers

ATOP's railway serial servers support two serial connectivity ports (RS-232/RS-485/RS-422) and one Ethernet port, and are enclosed into a waterproof IP68-rated rugged housing.

EN50155 Railway Waterproof Serial Device Server

-40°C 75°C

Pic	SKU	Description	RS232- RS485- RS422 M12	10/100 M12 Ports	Additional features
	SE8502-M12	Waterproof Ethernet to Serial device Server, EN 50155 certified	2	1	
	SE8502-Sis-M12	Waterproof Ethernet to Serial device Server, EN 50155 certified, 2 kV isolation.	2	1	2 kV isolation

Appendix: How to read the Brochure



IP Rating

This device has an Ingress Protection rating of IP30. IP30 devices have effective protection against tools and thick wires, but no protection against water. IP67 devices have absolute protection against dust and can operate submerged under one meter of water.



DIN-Rail

This device can be DIN-Rail mounted. Please check the product's respective data sheet to confirm if a rack-mount kit is included.



Rack-Mount

The device can be rack-mounted (1U standard). Please check the product's respective data sheet to confirm if a rack-mount kit is included.

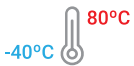

Operating Temperature

This device operates with 95% relative non-condensing humidity, and operates within the stated operating temperature range.



Redundant Power input

Equipped with redundant power supply for devices with embedded power supplies; or redundant power supply input for devices requiring external power supply.



Relay Output

Embedded with a Relay output feature.



Industrial EMC

Complies with the strictest EMC standards for Heavy Industrial Environments – such as EN 61000-6-2 and EN 61000-6-4.



MIL-STD Ruggedized

Complies with MIL-STD 810F, which is a strict environmental and shock-vibration standard for military applications.



Railway Certified

Complies with EN50155 and EN50121-4, which defines the environmental, vibration, and EMC requirements for devices used on Rolling stock, Trackside or other Railway applications.



IEC 61850-3 Certified

Complies with IEC 61850-3. This defines the temperature and EMC isolation standards devices should comply with in order to be used in IEC 61850 Power Grid networks.



ATEX Certified

Complies with the latest ATEX regulations relating to Explosive or Potentially Explosive atmospheres (ATEX). This device is also UL C1D2 certified.



Advanced Security

Embedded with advanced security features such as hardware-based MACsec Encryption or hardware-accelerated VPN Encryption. MACsec protocol guarantees link security, offering protection from packet-sniffing and unauthorized users.



PROFINET Certified

Certified as Profinet Conformance Class B version 2.33.



Layer-3 Switching

Capable of managing fast and reliable Layer-3 switching (IP Routing). It provides additional advanced features for implementing advanced security, such as MAC address and IP address filtering. More details available on respective data-sheets.



Precision Timing

Supports hardware-based IEEE 1588v2 Precision Time Protocol (PTP) transparent clock function and software-based boundary clock function. IEEE 1588v2 is the standard for network synchronization for nanosecond accuracy.



Redundant Ring

Supports ERPS-RSTP-MRP (client) Ring topologies for network redundancy. These ATOP's switches have a link recovery time of less than 20 milliseconds.



2 x 2 MIMO Wireless

Multiple-input, multiple-output to exploit multipath wave propagation by using two or more antennas. This enhances a device's data transmission performance.



WDS

ATOP wireless AP (Access Point) device that supports Wireless Distribution System (WDS) bridging. This feature allows the AP to act as a signal repeater in a multi-AP network.



New Product

This is a New ATOP's Product, planned to be released in Q2, 2018.



TAIWAN HEAD OFFICE

2F, No. 148, Sec. 1, Tung-Hsing Rd,
30261 Chupei City, Hsinchu County
Taiwan, R.O.C.
Tel: +888-3-550-8137
Fax: +886-3-550-8131
E-mail: sales@atop.com.tw

ATOP INDIA OFFICE

Abhishek Srivastava
Head of India Sales
Atop Communication Solutions(P) Ltd.
No. 22, Kensington Terrace,
Kensington Rd,
Bangalore, 560008, India
Tel: +91-80-4920-6363
E-mail: Abhishek.S@atop.in

ATOP EMEA OFFICE

Bhaskar Kailas (BK)
Vice President (Business Development)
Atop Communication Solutions(P) Ltd.
No. 22, Kensington Terrace,
Kensington Rd.
Bangalore, 560008, India
Tel: +91-988-0788-559
E-mail: Bhaskar.k@atop.in

ATOP AMERICAs OFFICE

Venke Char
Sr. Vice President & Head of Business
11811 North Tatum Blvd, Suite 3031
Phoenix, AZ 85028, United States
Tel: +1-602-953-7669
E-mail: venke@atop.in

ATOP CHINA BRANCH

3F, 75, No. 1086 Building,
Qingzhou North Road
Shanghai, China
Tel: +86-21-64956231

ATOP INDONESIA BRANCH

PT.Atop Indonesia Technologies
Wisma Slipi, Jl. Let.Jend. S. Parman Kav.
12, Unit : 308, Jakarta Barat 11480
Indonesia
Tel. (+62-21)5326171
Fax. (+62-21)5326172
E-mail : jopsonli@atop.com.tw

